

STH Pump Controller

Owner's Guide



This document was, as far as possible, accurate at the time of release. However, changes may have been made to the software and hardware it describes since then. ADInstruments NZ Limited reserves the right to alter specifications as required. Late-breaking information may be supplied separately.

Trademarks of ADInstruments

PowerLab®, LabChart® and ADInstruments® are registered trademarks of ADInstruments NZ Limited.

Other Trademarks

Apple, Mac and Macintosh are registered trademarks of Apple Computer, Inc.

Windows, Windows 7, Windows 8, Windows 10 and Windows Vista are either registered trademarks or trademarks of Microsoft Corporation.

All other trademarks are the property of their respective owners.

Document Number: U-IN175-OG-035B
Date of Issue: 06/20

Copyright © ADInstruments NZ Limited, 2020. All rights reserved. PowerLab, LabChart and ADInstruments are registered trademarks of ADInstruments NZ Limited. Windows 8, Windows 7, Windows 10, Windows Vista and .NET Framework are trademarks of Microsoft Corporation. Apple, the Apple logo, MacOS, and Macintosh are trademarks of Apple Computer Inc. registered in the U.S. and other countries. Acrobat and Adobe are registered trademarks of Adobe Systems Incorporated. Igor is a trademark of Wavemetrics Inc. MATLAB is a registered trademark of The MathWorks Inc. Grass is a trademark of Astro-Med Inc. All other trademarks are the property of their respective owners.

Web: www.adinstruments.com

Manufactured in Australia by:
ADInstruments (Sydney) Pty. Ltd.,
13/22 Lexington Drive
Bella Vista 2153 New South Wales

Technical Support: support.au@adinstruments.com

Contents

Safety Notes 5

1 Overview 13

How to Use This Guide	14
Checking the STH Pump Controller	14
The STH Pump Controller	14
The Front Panel	14
The Power Indicator	15
Pump Run/Stop Toggle Switch	15
Pump Forward/Reverse Toggle Switch	15
Set Flow Knob	15
Pressure Hold Button	15
Pressure Adjust Knob	15
The Back Panel	16
Pressure In BNC Socket	16
Flow Out Analog Output BNC Socket	16
I ² C Input and Output Sockets	16
Pump DIN Connector	17
Internal Gain Adjustment (Gain Adj.) Control	17
Adjust/Measure Switch	17
Flow Rate Low-pass Filter Switch	17

2 Using the STH Pump Controller 19

Connecting and Setting Up the STH Pump Controller	20
Connecting to the PowerLab and Bridge Amp	20
Connecting to other Bridge Amplifiers	21
Power-up Test	21
Perfusion System Setup	21
Pressure Line Damping	22
Priming the Perfusion Circuit – Air Bubble Removal	23
Testing the System	23
Calibration	24
Calibrating the Flow	24

Calibrating the Pressure Signal	25
The Pump Interface	26
Pump Control Connections	27
Pump Speed Control	27
Pump Run/Stop Control	27
Pump Forward and Reverse Control	28
A Technical Details	29
How it Works	30
Circuit Principles	30
Constant Flow Mode	30
Constant Pressure Mode	31
Pump Run and Direction Control	31
Power Supply	32
B Specifications	33
Controller Operation	33
Pump Control Signals	33
Flow Rate Output	33
Pressure Input	33
Operating Requirements	34
Physical Configuration	34
Warranty	35
Index	41



Safety Notes

Statement of Intended Use

All products manufactured by ADInstruments are intended for use in teaching and research applications and environments only. ADInstruments products are NOT intended to be used as medical devices or in medical environments. That is, no product supplied by ADInstruments is intended to be used to diagnose, treat or monitor a subject. Furthermore no product is intended for the prevention, curing or alleviation of disease, injury or handicap.

Where a product meets IEC 60601-1 it is under the principle that:

- it is a more rigorous standard than other standards that could be chosen.
- it provides a high safety level for subjects and operators.

The choice to meet IEC 60601-1 is in no way to be interpreted to mean that a product:

- is a medical device.
- may be interpreted as a medical device.
- is safe to be used as a medical device.

Safety Symbols

Devices manufactured by ADInstruments that are designed for direct connection to humans are tested to IEC 601-1:1998 (including amendments 1 and 2) and 60601-1-2, and carry one or more of the safety symbols below. These symbols appear next to those inputs and output connectors that can be directly connected to human subjects.



BF symbol: Body-protected equipment

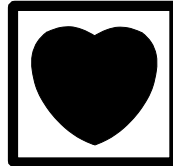

CF symbol: Cardiac-protected equipment



Warning symbol: See Documentation

The three symbols are:

- **BF (body protected) symbol.** This means that the input connectors are suitable for connection to humans provided there is no direct electrical connection to the heart.
- **CF (cardiac protected) symbol.** This means that the input connectors are suitable for connection to human subjects even when there is direct electrical connection to the heart.
- **Warning symbol.** The exclamation mark inside a triangle means that the supplied documentation must be consulted for operating, cautionary or safety information before using the device.

Further information is available on request.

Bio Amp Safety Instructions

The Bio Amp inputs displaying any of the safety symbols are electrically isolated from the mains supply in order to prevent current flow that may otherwise result in injury to the subject. Several points must be observed for safe operation of the Bio Amp:

- All Bio Amp front-ends (except for the FE138 Octal Bio Amp) and all PowerLab units with a built-in Bio Amp are supplied with a 3-lead or 5-lead Bio Amp subject cable and lead wire system. The FE138 Octal Bio Amp is supplied with unshielded lead wires (1.8 m). Bio Amps are only safe for human connection if used with the supplied subject cable and lead wires.

-
- All Bio Amp front-ends and PowerLab units with a built-in Bio Amp are not defibrillator-protected. Using the Bio Amp to record signals during defibrillator discharges may damage the input stages of the amplifiers. This may result in a safety hazard.
 - Never use damaged Bio Amp cables or leads. Damaged cables and leads must always be replaced before any connection to humans is made.

Isolated Stimulator Safety Instructions

The Isolated Stimulator outputs from a front-end signal conditioner or a PowerLab with a built-in isolated stimulator are electrically isolated. However, they can produce pulses of up to 100 V at up to 20 mA. Injury can still occur from careless use of these devices. Several points must be observed for safe operation of the Isolated Stimulator:

- The Isolated Stimulator output must only be used with the supplied bar stimulus electrode.
- The Isolated Stimulator output must not be used with individual (physically separate) stimulating electrodes.
- Stimulation must not be applied across the chest or head.
- Do not hold one electrode in each hand.
- Always use a suitable electrode cream or gel and proper skin preparation to ensure a low-impedance electrode contact. Using electrodes without electrode cream can result in burns to the skin or discomfort for the subject.
- Subjects with implantable or external cardiac pacemakers, a cardiac condition, or a history of epileptic episodes must not be subject to electrical stimulation.
- Always commence stimulation at the lowest current setting and slowly increase the current.
- Stop stimulation if the subject experiences pain or discomfort.
- Do not use faulty cables, or those that have exhibited intermittent faults.
- Do not attempt to measure or record the Isolated Stimulator waveform while connected to a subject using a PowerLab input or any other piece of equipment that does not carry the appropriate safety symbol (see Safety Symbols above).

Always check the status indicator on the front panel. It will always flash green each time the stimulator delivers a current pulse. A yellow flash indicates an ‘out-of-compliance’ (OOC) condition that may be due to poor electrode contact or electrode cream drying up. Always ensure that there is good electrode contact at all times. Electrodes that are left on a subject for some time need to be checked for dry contacts. An electrode impedance meter can be used for this task.

- Always be alert for any adverse physiological effects in the subject. At the first sign of a problem, stimulation must be stopped, either from the software or by flicking down the safety switch on the front panel of any built-in Isolated Stimulator or the FE180 Stimulus Isolator.
- The FE180 Stimulus Isolator is supplied with a special transformer plug pack. The plug pack complies with medical safety requirements. Therefore, under no circumstances should any other transformer be used with the Stimulus Isolator. For a replacement transformer plug pack please contact your nearest ADInstruments representative.

General Safety Instructions

To achieve the optimal degree of subject and operator safety, consideration should be given to the following guidelines when setting up a PowerLab system either as stand-alone equipment or when using PowerLab equipment in conjunction with other equipment. Failure to do so may compromise the inherent safety measures designed into PowerLab equipment.

The following guidelines are based on principles outlined in the international safety standard IEC60601-1-1: *General requirements for safety - Collateral standard: Safety requirements for medical systems*. Reference to this standard is required when setting up a system for human connection.

PowerLab systems (and many other devices) require the connection of a personal computer for operation. This personal computer should be certified as complying with IEC60950 and should be located outside a 1.8 m radius from the subject (so that the subject cannot touch it while connected to the system). Within this 1.8 m radius, only equipment complying with IEC60601-1 should be present. Connecting a system in this way obviates the provision of additional safety measures and the measurement of leakage currents.

Accompanying documents for each piece of equipment in the system should be thoroughly examined prior to connection of the system.

While it is not possible to cover all arrangements of equipment in a system, some general guidelines for safe use of the equipment are presented below:

- Any electrical equipment which is located within the SUBJECT AREA should be approved to IEC60601-1.
- Only connect those parts of equipment that are marked as an APPLIED PART to the subject. APPLIED PARTS may be recognized by the BF or CF symbols which appear in the Safety Symbols section of these Safety Notes.
- Only CF-rated APPLIED PARTS must be used for direct cardiac connection.
- Never connect parts which are marked as an APPLIED PART to those which are not marked as APPLIED PARTS.
- Do not touch the subject to which the PowerLab (or its peripherals) is connected at the same time as making contact with parts of the PowerLab (or its peripherals) that are not intended for contact to the subject.
- Cleaning and sterilization of equipment should be performed in accordance with manufacturer's instructions. The isolation barrier may be compromised if manufacturer's cleaning instructions are not followed.
- The ambient environment (such as the temperature and relative humidity) of the system should be kept within the manufacturer's specified range or the isolation barrier may be compromised.
- The entry of liquids into equipment may also compromise the isolation barrier. If spillage occurs, the manufacturer of the affected equipment should be contacted before using the equipment.
- Many electrical systems (particularly those in metal enclosures) depend upon the presence of a protective earth for electrical safety. This is generally provided from the power outlet through a power cord, but may also be supplied as a dedicated safety earth conductor. Power cords should never be modified so as to remove the earth connection. The integrity of the protective earth connection between each piece of equipment and the protective earth should be verified regularly by qualified personnel.
- Avoid using multiple portable socket-outlets (such as power boards) where possible as they provide an inherently less safe environment with respect to electrical hazards. Individual connection of each piece of equipment to fixed mains socket-outlets is the preferred means of connection.

If multiple portable socket outlets are used, they are subject to the following constraints:

- They shall not be placed on the floor.
- Additional multiple portable socket outlets or extension cords shall not be connected to the system.
- They shall only be used for supplying power to equipment which is intended to form part of the system.

Cleaning and Sterilization

ADInstruments products may be wiped down with a lint free cloth moistened with industrial methylated spirit. Refer to the Data Card supplied with transducers and accessories for specific cleaning and sterilizing instructions.

Preventative Inspection and Maintenance

PowerLab systems and ADInstruments front-ends are all maintenance-free and do not require periodic calibration or adjustment to ensure safe operation. Internal diagnostic software performs system checks during power up and will report errors if a significant problem is found. There is no need to open the instrument for inspection or maintenance, and doing so within the warranty period will void the warranty.

Your PowerLab system can be periodically checked for basic safety by using an appropriate safety testing device. Tests such as earth leakage, earth bond, insulation resistance, subject leakage and auxiliary currents and power cable integrity can all be performed on the PowerLab system without having to remove the covers. Follow the instructions for the testing device if performing such tests.

If the PowerLab system is found not to comply with such testing you should contact your PowerLab representative to arrange for the equipment to be checked and serviced. Do not attempt to service the device yourself.

Environment

Electronic components are susceptible to corrosive substances and atmospheres, and must be kept away from laboratory chemicals.

Storage Conditions

- Temperature in the range 0–40 °C
- Non-condensing humidity in the range 0–95%.

Operating Conditions

- Temperature in the range 5–35 °C
- Non-condensing humidity in the range 0–90%.

Disposal

- Forward to recycling center or return to manufacturer.
- Unwanted equipment bearing the Waste Electrical and Electronic Equipment (WEEE) Directive symbol requires separate waste collection. For a product labeled with this symbol, either forward to a recycling center or contact your nearest ADInstruments representative for methods of disposal at the end of its working life.



WEEE Directive
symbol

Overview

The ADInstruments IN175 STH Pump Controller is an instrument designed to control the flow of perfusate solutions in isolated organ experiments. The STH Pump Controller, when used with an external pump, delivers either constant flow, or constant pressure perfusion controlled by a feedback circuit.

This Owner's Guide covers the features of the STH Pump Controller and its operation with your ADInstruments PowerLab® and LabChart software.

How to Use This Guide

This owner's guide describes how to set up and begin using your STH Pump Controller. Topics discussed included how to connect the hardware, perform a simple power-up test and calibration of the STH Pump Controller. The appendices provide technical information about the STH Pump Controller and look at some potential problems and their solutions. An index is included at the end of the guide.

Checking the STH Pump Controller

The unit will have passed quality control inspection before leaving the factory. However, there is a small chance that some damage may occur during transit.

1. Check that there are no signs of damage to the outside casing.
2. Check that there is no obvious sign of internal damage, such as rattling.

If you find a problem, please contact your ADInstruments distributor immediately.

The STH Pump Controller

The remainder of this chapter contains general information about the features, connections, and indicators of the STH Pump Controller. More detailed information can be found in Appendix A.

The Front Panel

Figure 1-1
The front panel of the
STH Pump Controller

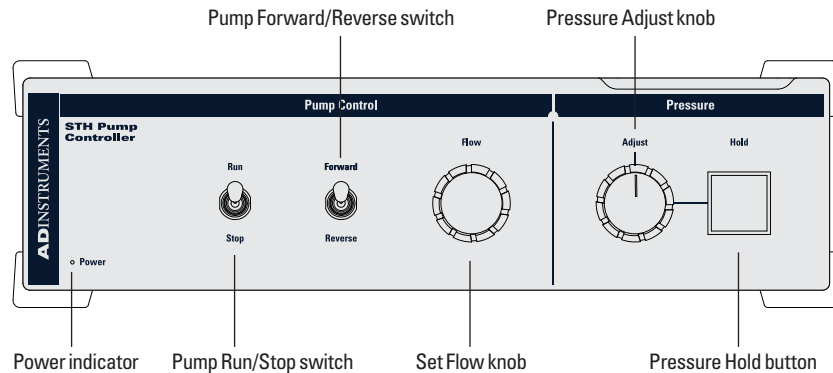

The Power Indicator

The Power indicator will light when the unit is on. If not, check that the unit is properly connected to the PowerLab, and that the PowerLab is properly connected to a power socket and is switched on.

Pump Run/Stop Toggle Switch

This switch opens or closes a circuit to remotely “run” or “stop” a pump (if the pump supports this feature). The contact closure output is two pins on the Pump connector (6 pin DIN) on the back panel.

Pump Forward/Reverse Toggle Switch

This switch can control the direction of an attached pump, if the pump supports external direction control. The toggle switch activates a contact closure output on the Pump connector (6 pin DIN).

Set Flow Knob

When the controller is in constant flow mode, the Set Flow knob allows the speed, and hence the flow rate, of the pump to be adjusted. Note: the Set Flow knob allows precise control of the flow rate. Thus to go from zero flow (0 volt output) to full flow (5 volt output) you make 10 turns of the knob. The control voltage is sent through two pins on the Pump connector (6 pin DIN) on the back panel. The knob has no effect when the controller is in the constant pressure mode.

Pressure Hold Button

Select either constant flow or constant pressure mode with the Pressure Hold button. When the button is not lit, the controller is in constant flow mode and the flow rate of the pump can be adjusted with the Set Flow knob. When the button is depressed and illuminated, the unit is in constant pressure mode. In this mode the STH Pump Controller holds the perfusion pressure at the value that was present when constant pressure mode was selected. It uses the pressure signal, from the Pressure In BNC connector on the back panel, as a control signal to maintain the pressure at that preset level.

Pressure Adjust Knob

When the controller is in constant pressure mode, the Pressure Adjust knob allows you to trim the pressure by up to $\pm 5\%$ of the initial pressure signal.

Figure 1-2
The back panel of the
STH Pump Controller

The Back Panel

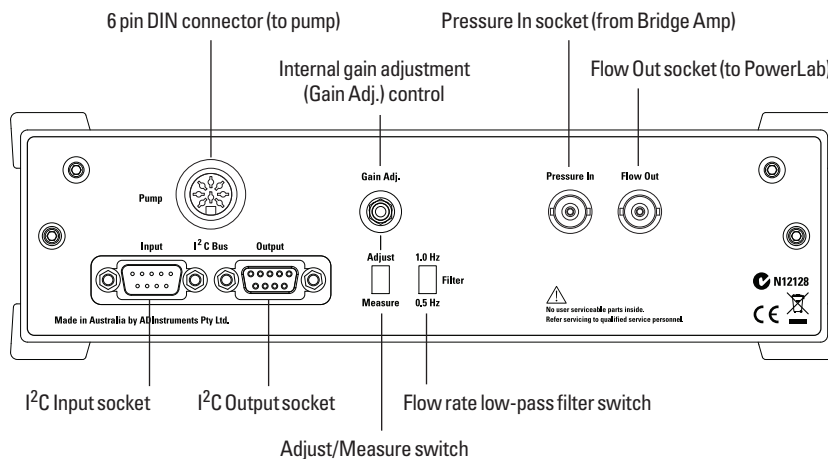

Pressure In BNC Socket

In constant pressure mode, the STH Pump Controller uses the signal on this input as feedback to adjust flow to maintain a constant pressure. The pressure monitored at the Pressure In socket is compared to the perfusion pressure set point, and the pump controller continuously adjusts the control voltage to the pump to maintain the set pressure. The STH Pump controller is factory calibrated to use a Bridge Amp as the signal source for this input.

Flow Out Analog Output BNC Socket

The STH Pump Controller produces an analog voltage that is proportional to the flow rate delivered by the pump. The Flow Out signal is connected to one of the analog input channels of your PowerLab to provide a continuous reading of the perfusate flow rate. Units Conversion can then be used to calibrate the flow rate in terms of mL/min, or other appropriate units.

I²C Input and Output Sockets

The STH Pump Controller is designed to be powered from an ADInstruments PowerLab system. Power and control signals are supplied using a connection called the I²C (eye-squared-sea) Bus. In the case of the STH Pump Controller, the I²C Input is used to connect to a Bridge Amp I²C Output. The I²C Output is used to connect other ADInstruments front-end devices to the system.

Pump DIN Connector

The STH Pump Controller provides three pairs of control signals to an external pump through a 6 pin DIN connector on the rear of the unit, provided that the pump supports these features. These three outputs correspond to the three controls on the front panel. They are:

- The pump can be remotely switched on and off (controlled by the run/stop toggle switch).
- The pump can be set to run in forward or in reverse (controlled by the forward/reverse toggle switch).
- Pump speed is controlled by an analog voltage output (0 to +5 V) (controlled by the Set Flow knob).

Pin assignments of this connector are given in Figure 2–3 in Chapter 2.

Internal Gain Adjustment (Gain Adj.) Control

Before using the STH Pump Controller for the first time, it is necessary to adjust the internal gain of the system to match the pressure transducer and its signal conditioner (for example, the ADInstruments FE221 Bridge Amp). This adjustment will only need to be repeated if a different model of pressure transducer or signal conditioner is used. Adjustment of the internal gain is discussed in the next chapter.

Adjust/Measure Switch

This switch selects the signal applied to the Flow Out socket on the rear panel. With the switch in the Adjust position, the signal from the Flow Out socket can assist in setting up the controller's calibration and adjusting the internal gain. In this position the voltage gain can be adjusted using the Gain Adj. control.

In the Measure position, the Flow Out socket sends out a voltage signal, proportional to the flow rate of the pump, to the PowerLab device for recording. The switch must be in this position to use the STH Pump Controller for recording.

Flow Rate Low-pass Filter Switch

The Filter switch is used to select the cut-off frequency (-3 dB point) of the low-pass filter on the Flow Out signal. This filter is designed to remove unwanted fluctuations in the flow rate signal. You can choose to set it to 0.5 Hz or 1 Hz by sliding the switch to that position.

2

Using the STH Pump Controller

This chapter guides you through connecting the STH Pump Controller to a PowerLab and performing a power-up test to make sure that there are no problems. This chapter also explains how to set up the controller in a typical system, calibrate the flow and pressure signals and use the STH Pump controls.

IMPORTANT: Always make sure that the PowerLab is turned off before you connect or disconnect the STH Pump Controller. Failure to do so may damage the PowerLab and/or the STH Pump Controller.

Connecting and Setting Up the STH Pump Controller

Connecting to the PowerLab and Bridge Amp

When connecting the STH Pump Controller to your PowerLab system, first make sure that the PowerLab is turned off.

Figure 2-1
Rear view showing the STH Pump Controller connected to a Bridge Amp and PowerLab

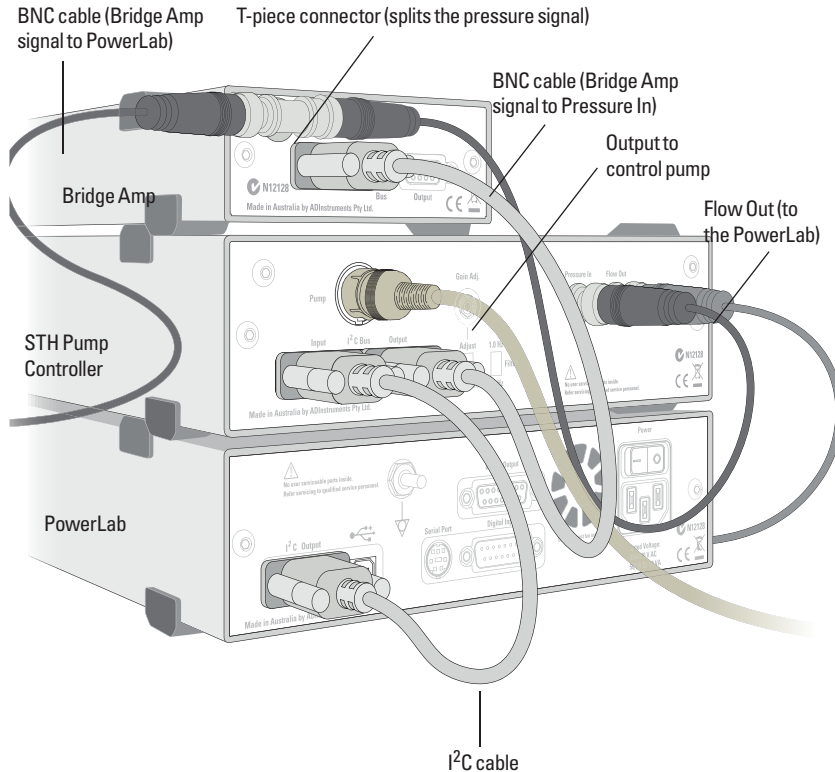

Connect the PowerLab to your computer, as recommended in the PowerLab Owner's Guide. With I²C cables, connect the I²C Output of the PowerLab to the I²C Input of the STH Pump, and the I²C Output of the STH Pump to the I²C Input of the ADInstruments Bridge Amp (as shown in Figure 2-1).

Other ADInstruments front-end devices may be added to the system by connecting them to the I²C Output of the Bridge Amp.

With a BNC cable, connect the Flow Out socket of the STH Pump Controller to one of the analog inputs of your PowerLab

Perfusion pressure is measured using a pressure transducer connected to the Bridge Amp. The supplied T-piece is used to split the pressure signal from the Signal Output socket at the rear of the Bridge Amp to one of the input channels of the PowerLab and to the Pressure In socket of the STH Pump Controller. With BNC cables, connect the T-piece connector to these sockets (see Figure 2-1).

Connecting to an External Pump

The STH Pump Controller connects to an external pump using the Pump 6 pin DIN connector on the rear of the unit. A suitable cable is required for connection to the pump.

A cable compatible with a Gilson Minipuls 3 peristaltic pump is supplied as standard with your STH Pump Controller. Other peristaltic pumps which have similar controls can be adapted to this system, either by adapting this cable or making a custom cable.

Note: the pump should have a sufficient number of rollers (at least six) to minimise pulsatile flow in the constant flow mode.

Connecting to other Bridge Amplifiers

The STH Pump Controller is designed to allow it to be used with a variety of bridge amplifiers or signal conditioners that produce different output voltages per unit of pressure. This is accomplished by including an adjustable gain on the pressure input to the unit.

Power-up Test

Once the STH Pump Controller has been properly connected to the PowerLab, the PowerLab can be switched on to perform an initial check of the STH Pump Controller. No sampling is required to perform this test. To perform the power-up test, follow these steps:

1. Connect your STH Pump Controller to your recorder and signal conditioner, as shown in Figure 2-1.
2. Turn on your PowerLab. The PowerLab should perform its normal diagnostic tests, as described in the PowerLab Owner's Guide.
3. The STH Pump Controller power indicator light should light.

Perfusion System Setup

A typical perfusion setup will consist of some of the components shown in Figure 2-2. At the most basic level, the setup will consist of a PowerLab recording unit, a STH Pump Controller, a Bridge Amp, a peristaltic pump and

associated perfusion glassware and plumbing. Depending on the complexity and requirements of your experimental setup, you can also add a Stimulator, a Bio Amp for recording ECG, or a temperature pod for recording perfusate temperature.

Figure 2–2 gives an indication of the way in which a perfusion system can be fully configured with a PowerLab to record all key parameters.

Figure 2–2
Block diagram of an experimental setup including the STH Pump Controller. Note the air filled syringe for pressure damping

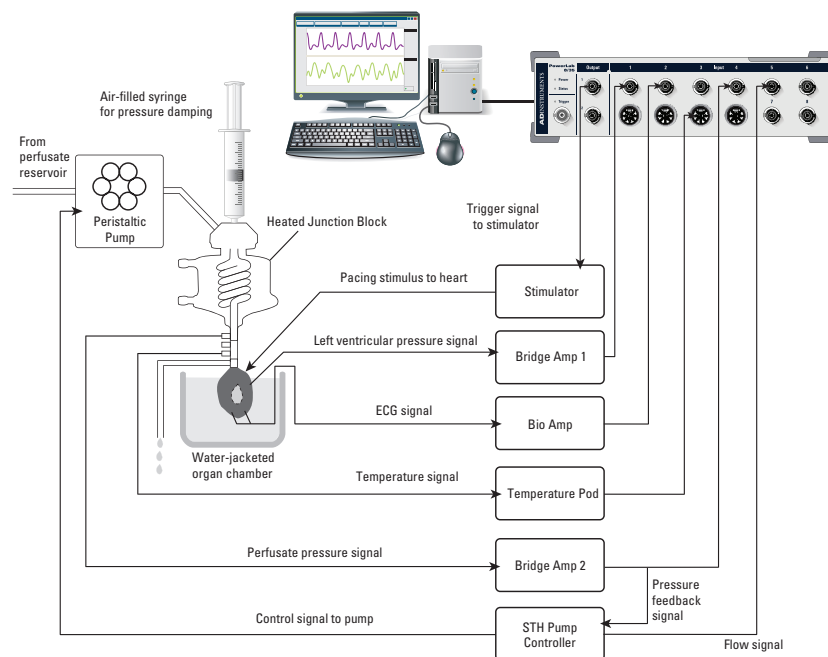

There are several things that must be done to the perfusion system setup to get the best performance out of the STH Pump Controller. The following information is critical in getting your perfusion system working correctly with the STH Pump Controller.

Pressure Line Damping

To minimize pressure oscillations in the system (mainly due to the rollers of the pump), it is essential to have some form of pressure damping in the fluid line between the pump and the organ undergoing perfusion. This can be provided by a syringe containing several millilitres of air connected to a T-piece in the flow circuit.

This is essential to allow the STH Pump Controller to accurately control the pressure. Good results can be obtained with a 20 mL syringe with around 10 mL of air in it.

Priming the Perfusion Circuit – Air Bubble Removal

Before starting any experiment it is essential to prime (remove air from) the perfusion circuit. This will prevent false readings or sudden pressure drops. Generally, running the pump at a high speed is enough to force air from the system. However, air may still become trapped and the tube may need to be shaken to loosen air pockets or bubbles.

Make sure your pressure transducer is also free from air bubbles as this may effect the readings, and will certainly give a shift in pressure if an air bubble dislodges during an experiment.

Testing the System

1. Open LabChart on your computer and set it up for the two channels that are attached to the STH Pump Controller and the Bridge Amplifier. The input connected to the Flow Out on the STH Pump controller will become the Perfusate Flow monitoring channel and the input connected to the T-piece from the Signal Output of the Bridge Amp will become the Perfusate Pressure channel.
2. For a quick check of the system try using LabChart with a sampling rate of 400 samples per second, the flow channel with a range of 10 V and the pressure channel with a range of 10 mV. In the Bridge Amplifier dialog box, select DC from the **High-pass** filter pop-up menu and 10 Hz from the **Low-pass** filter pop-up menu.
3. Click the **Start** button in LabChart and then start the pump running. Make sure that the pump is running in the appropriate direction. Use the Forward/Reverse switch on the front panel of the STH Pump Controller to change the direction.
4. Try varying the pump speed using the Set Flow knob on the front panel of the STH Pump Controller. Turning the knob clockwise should increase the pump's speed and you should also observe that the flow rate being recorded increases as well. Turning the Set Flow knob anticlockwise will slow the pump down with a corresponding decrease in signal on the flow channel. You will also notice that the pressure signal will also go up with increasing flow and decrease with decreasing flow.

If this is what you are observing, then the system is ready to calibrate.

Calibration

The flow signal (from the STH Pump Controller) and pressure signal (from the Bridge Amp) can be calibrated in appropriate units using LabChart's Units Conversion feature. For the remainder of this chapter it is assumed that you are using a PowerLab with LabChart software. While the discussion specifically refers to LabChart software, the principles of calibration and scaling apply to any meter that you attach to the STH Pump Controller/Bridge Amp.

Calibrating the Flow

The relationship between pump control voltage, pump speed and flow rate will depend on the type of pump, the number of rollers and the diameter of the tubing used. Due to this variance we cannot provide a simple calibration factor. You will need to determine the flow rate for your particular setup.

The simplest way to calibrate the flow rate is to run the pump at a fixed speed and determine how long it takes for a specific amount of perfusate to be pumped through the system. This is easily done with a measuring cylinder or other fluid measurement container. You can either use LabChart or a stopwatch to determine the time taken to fill a set amount in the container.

To obtain accurate results, it is best to run the pump at the speed required to reach the maximum pressure you need. It is also recommended to pump a reasonable quantity of fluid through the pump to obtain a better estimate of the flow rate.

To calibrate the flow, follow these steps:

1. In the Input Amplifier dialog box for the channel reading the flow signal, make sure the range is set to 10 V.
2. Set the speed of the pump using the Set Flow knob to give full pump speed or a significant percentage of full speed.
3. Stop the pump and place a suitable measuring container at the outlet of the perfusate line. Before starting the pump decide how much fluid you will pump through to calibrate the system. Remember that the more fluid you pump through, the more accurate the calibration.
4. Click **Start** in LabChart to start recording and then start the pump. Leave it running until the pump has transferred the required amount of fluid.
5. Stop the pump then click **Stop** in LabChart.
6. Measure the amount of time taken to transfer the measured volume by using the Marker, or by manually measuring the duration of pumping.

7. The flow rate for this setting can be easily calculated by dividing the amount of fluid transferred by the time taken (in minutes or seconds, whatever is appropriate) to transfer it.
8. Select a portion of the data recorded while you were pumping and then choose Units Conversion for the flow channel.
9. Set the first conversion point as 0 volts = 0 flow and set the second point to be the value of the recorded signal. This point should be set to be the calculated value of flow rate. Make sure you click **Apply** to ensure that the conversion takes place. This assumes that your pump has a linear relationship between flow rate and voltage. See the LabChart Help Center for further details.

Calibrating the Pressure Signal

Calibrating the pressure channel in LabChart is straightforward. The pressure channel needs to be calibrated in terms of mmHg or similar pressure units to simplify the recording process. The calibration is different for different types of transducers and amplifier combinations. Once a particular transducer and amplifier are calibrated, that calibration can be used repeatedly. However, for accurate results it is always a good idea to calibrate the pressure for each experiment.

To calibrate pressure you need a manometer or other pressure measurement device, and a rubber bulb or similar way of adjusting the pressure in the system.

To calibrate the pressure, follow these steps:

1. Go to the Bridge Amp dialog box and with no pressure applied to the pressure transducer, let the signal scroll in the dialog box for a few seconds. Then click the Pause button.
2. Using a rubber bulb and manometer, set up a known pressure into the pressure transducer. Try to set up a pressure close to the working pressure for your experiments, for example 100 mmHg.
3. When you have a stable working pressure, click the Play button until the new signal is about half the time axis in the scrolling display. Click the Pause button again. (See the LabChart Help Center, or your Bridge Amp Owner's Guide).
4. Click the Units Conversion button to add both readings to the two point conversion text boxes. The first reading corresponds to 0 mmHg and the second to the pressure you set. Make sure you click **Apply** to ensure that the conversion takes place.

You should now have a pressure channel calibrated in pressure units ready to record.

Pressure Gain Adjustment

The first time the unit is used with a particular combination of pressure transducer and signal conditioner, it is necessary to adjust the internal gain of the system to optimize the performance of the STH Pump controller. Although the STH Pump Controller is factory calibrated to be used with a Bridge Amplifier and ADInstruments pressure transducers, you may be using a combination of transducer and third party amplifier that requires readjustment.

To set the gain adjustment to suit your particular setup:

1. With the system fully set up (connected and power on), slide the Adjust/Measure switch on the back panel of the STH Pump Controller to the Adj. position.
2. Using a pressure source or even a real setup, set the flow rate of the system to produce your nominal operating pressure.
3. Run LabChart and open the Input Amplifier dialog box for the flow input from the STH Pump Controller.
4. Using a small flat blade screwdriver, adjust the Gain Adj. control on the back panel of the STH Pump Controller until the signal in the Input Amplifier dialog box is around +5 volts.
5. Switch the Adjust/Measure switch back to the Measure position.

Pressure gain adjustment is required if you change transducers or amplifier arrangement. It is also good practice to repeat this gain adjustment from time to time to keep the STH Pump controller at its nominal operating point.

Note: if you do not perform this adjustment correctly, the STH Pump Controller may not have enough range in which to control the pump. This means that the pump may not be able to maintain the pressure in the system in the constant pressure mode because it will not be able to speed up or slow down the pump sufficiently.

The Pump Interface

The STH Pump Controller is supplied with a cable designed to work directly with a Gilson Minipuls 3 peristaltic pump. This pump is specifically designed for external control and is thus ideal for use with the STH Pump Controller. If you intend to connect the STH Pump Controller to other brands of peristaltic pumps then the information in this section can be used to determine the correct connections.

Connection to a pump is by means of a 6 pin DIN connector on the rear panel of the STH Pump Controller. This connector provides 3 signal pairs to control pump speed, pump operation (run or stop), and pump direction

(forward or reverse). Some pumps may only have the capability for speed control or pump run/stop. You will need to consult the technical manual for your particular pump to determine if it is possible to connect it to the STH Pump Controller.

Pump Control Connections

The 6 pin Pump connector on the rear panel of the STH Pump Controller has the pin assignments shown in Figure 2–3. Note: the signals are grouped into three groups, although the grounds are actually common.

Figure 2–3
The Pump connector pin assignments

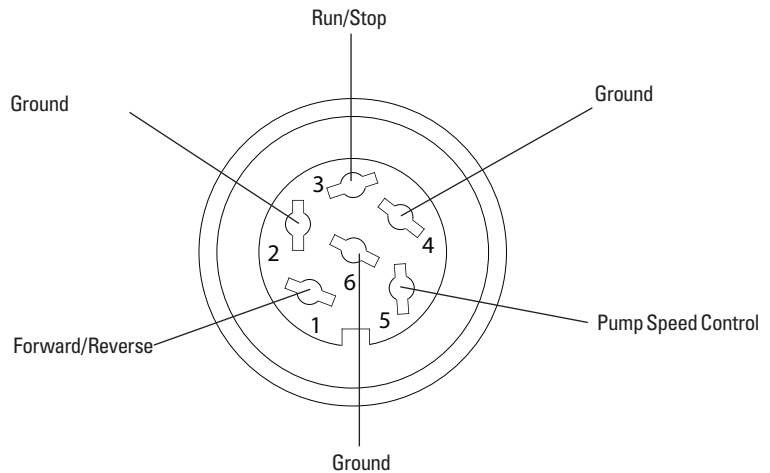

Pump Speed Control

The STH Pump Controller provides an analog voltage to control pump speed. This is adjustable in the range 0 to +5 volts, corresponding to no pump flow and maximum pump flow, respectively. Pumps that require a 0–5 V control range will work directly with the STH Pump Controller. Pumps that have a 0–10 V control voltage range may still work, as 0–5 volts may be a sufficient range for the pressure to be maintained. Generally, pumps will only run at a fraction of full speed to produce the sort of flow rates commonly used on animal heart perfusions. To control an external pump you should connect pin 5 to the appropriate pump speed control input and use pin 6 as the ground reference.

Pump Run/Stop Control

If the pump supports external run/stop control by contact closure, then you can use the run/stop signal from the pump interface connector. The run/stop contact closure will need a ground reference along with the signal in order for it to work correctly, so you must use pins 3 and 4 of the pump interface

connection. Pin 4 will be fixed at ground potential and when the run/stop switch is toggled there will be a short circuit (contact closure) applied between pins 3 and 4. The short circuit applies when the switch is in the run position.

Pump Forward and Reverse Control

If the pump supports external direction control by contact closure, then you can use the forward/reverse contact closure from the pump interface connector. The forward/reverse contact closure needs a ground reference to work correctly so you must use pins 1 and 2 from the pump interface connector. Pin 2 will be fixed at ground potential and pin 1 is the closure terminal. A short circuit is applied between these terminals when the forward/reverse switch on the STH Pump Controller is in the reverse position.

A large, bold, grey letter 'A' is the central focus. It is surrounded by a network of thin, light-grey lines that form a complex geometric pattern, including triangles and polygons, extending across the top and sides of the header area.

Technical Details

■

This Appendix describes some important technical aspects of the STH Pump Controller's operation. You do not need to know this material to operate the STH Pump Controller. It is likely to be of interest to the technically-minded and is not intended in any way as a service guide.

It should be noted that any modification or attempt to service your STH Pump Controller voids your rights under the warranty.

How it Works

The STH Pump Controller is essentially an electronic feedback control system. By applying a pressure signal to the pressure input, the controller can constantly adjust the flow rate of the system to maintain constant pressure perfusion. The system integrates with PowerLab data recorders and a Gilson Minipuls 3 peristaltic pump, providing online measurement of vascular flow (coronary flow in the case of a Langendorff heart) and eliminating the need for cumbersome hydrostatic columns to deliver constant pressure perfusion. The STH Pump Controller can be adapted to a range of other pumps.

Circuit Principles

To understand the operation of the STH Pump controller, refer to Figure A-1 which shows a simplified block diagram of the system.

Figure A-1
Block diagram of the STH
Pump Controller

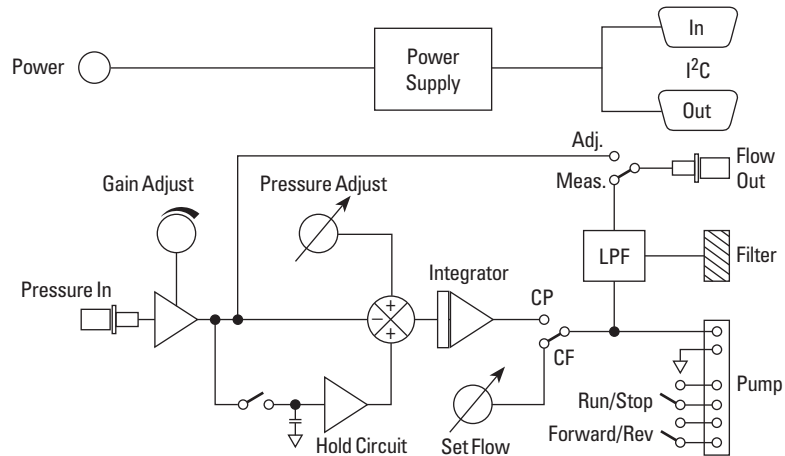

The STH Pump Controller operates in two modes; constant flow or constant pressure.

Constant Flow Mode

In constant flow mode the STH Pump Controller drives the pump by providing it with a control voltage. Increasing the voltage increases the speed of the pump and hence the flow rate. The flow rate is adjusted using the Set Flow knob on the front panel.

The controller is designed to produce a voltage in the range 0 to +5 volts to drive a Gilson Minipuls 3 peristaltic pump. The control voltage signal to the pump is provided on the Flow Out socket, located on the back panel,

and connected to one of the PowerLab input channels. This is to monitor continuous flow rate using a PowerLab system. This signal is low-pass filtered at either 0.5 Hz or 1 Hz depending on the setting on the rear panel. This removes higher frequency noise from the signal and presents a smooth flow signal to the recording device.

Constant Pressure Mode

In constant pressure mode the pump controller operates as a feedback control system. It uses the pressure of the perfusate solution to adjust the flow rate of the pump to keep the pressure at a preset level. To understand the operation of the system in constant pressure mode, it is important to understand the operation of the circuit in constant flow mode. This is the mode that is used to set up the desired pressure before entering into constant pressure mode.

When in constant flow mode, the Set Flow knob will be adjusted to give the desired operating pressure from the pump. During this process, the controller is continuously tracking or following the pressure value present on the Pressure In connection. This pressure signal appears as a corresponding voltage across a capacitor in a track and hold circuit (the switch before the capacitor being closed in this mode).

When constant pressure mode is selected, the switch at the input to the hold capacitor is opened, and the pump control signal is connected to the output of the integrator (the C.P. position of the switch in the block diagram). The pressure value at the time the switch was opened is held by the capacitor, and fed to a summing junction and used as a pressure set point value. This set point value is compared to the actual pressure reading on the Pressure In connector. The difference between this and the set point value causes the integrator to adjust the pump's flow rate to keep the pressure constant. An increase in pressure will cause the pump to slow down and a decrease in pressure will cause the pump to speed up.

To make fine adjustments to the pressure, an adjustment on the front panel allows the set point value to be altered in the range $\pm 5\%$ to $\pm 10\%$ of the pressure reading.

Pump Run and Direction Control

Control of the pump motor and direction is simply achieved by contact closures. The Run/Stop switch and the Forward/Reverse switch on the front panel provide a short circuit or open circuit signal to control the pump.

Power Supply

Power for the STH Pump Controller is derived from the I²C bus of a PowerLab or MacLab. The controller is fitted with both input and output connectors so that it can be used in a chain with other ADInstruments front-ends.

B

Specifications

Controller Operation

Modes:	Constant Flow or Constant Pressure
Flow Rate Error:	$\pm 3\%$ (~3 s to stabilize after change)
Constant Pressure Error:	± 1 mmHg
Drift in Constant Pressure:	< 1% over 30 min

Pump Control Signals

Run/Stop Control:	Contact closure (Run : contact closure)
Forward/Reverse Control:	Contact closure (Reverse : contact closure)
Pump Control Voltage:	0 to +5 V (+5 V : max pump speed)

Flow Rate Output

Flow Rate Signal Range:	0 to +5 Volts (+5 V : max flow rate)
Output Filtering:	0.5 Hz or 1 Hz, 2nd order, low-pass, switch-selectable

Pressure Input

Max Input Voltage:	± 15 V
Input Impedance:	100 k Ω

Input Gain range: × 1 to × 100, adjustable from rear panel
(to suit a wide variety of external signal
conditioners)

Operating Requirements

Power Requirements: +9 V @ 100 mA, ±18 V @ 50 mA

Operating Conditions: 5–35 °C, 0–90% humidity
(non-condensing)

Physical Configuration

Dimensions (h × w × d): 70 mm × 240 mm × 260 mm
(2.70" × 9.45" × 10.2")

Weight: 2.3 kg

ADInstruments reserves the right to alter these specifications at any time.

Warranty

Product Purchase and License Agreement

This Agreement is between ADInstruments NZ Limited [‘ADI’] and the purchaser [‘the Purchaser’] of any ADI product or solution — software, hardware or both — and covers all obligations and liabilities on the part of ADI, the Purchaser, and other users of the product. The Purchaser (or any user) accepts the terms of this Agreement by using the product or solution. Any changes to this Agreement must be recorded in writing and have ADI’s and the Purchaser’s consent.

Responsibilities

The Purchaser and any others using any ADI product or solution agree to use it in a sensible manner for purposes for which it is suited, and agree to take responsibility for their actions and the results of their actions. If problems arise with an ADI product, ADI will make all reasonable efforts to rectify them. This service may incur a charge, depending on the nature of the problems, and is subject to the other conditions in this Agreement. ADI does not separately warrant the performance of products, equipment or software manufactured by third parties which may be provided to Purchaser as part of an overall solution. However, as further noted below, ADI will pass through to Purchaser all applicable third party warranties to the extent it has the right to do so.

Statement of Intended Use

Products supplied by ADInstruments are intended for use in teaching and research applications and environments.

Products supplied by ADInstruments are NOT intended to be used as medical devices or in medical environments. That is, no product supplied by ADInstruments is intended to be used to diagnose, treat, or monitor a

subject. Furthermore no product is intended for the prevention, curing or alleviation of disease, injury or handicap.

Where a product meets IEC 60601-1 it is under the principle that:

1. it is a more rigorous standard than other standards that could be adopted and
2. it provides the most appropriate safety level for subjects and operators.

The choice to meet IEC 60601-1 is in no way to be interpreted to mean that a product:

1. is a medical device;
2. may be interpreted as a medical device;
3. is safe to be used as a medical device

ADI Product Hardware Warranty

ADI warrants that PowerLab Data Acquisition Units (PL prefix)¹ and Front-ends (FE prefix)² shall be free from defects in materials and workmanship for five (5) years from the date of purchase. Other PowerLab Data Acquisition Units³, Front-ends⁴ and Pods⁵ shall be free of defects in material and workmanship for three (3) years from their date of purchase. ADI also warrants that ADI Specialized Data Recorders⁶ and Instruments⁷ shall be free of defects in material and workmanship for one (1) year from their date of purchase. If there is such a defect, as Purchaser's sole remedy hereunder, ADI will repair or replace the equipment as appropriate, and the duration of the warranty shall be extended by the length of time needed for repair or replacement.

To obtain service under this warranty, the Purchaser must notify the nearest ADI office, or Authorized Representative, of the defect before the warranty expires. The ADI or Representative office will advise the Purchaser of the nearest service center address to which the Purchaser must ship the defective product at his or her own expense. The product should be packed safely, preferably in its original packaging. ADI will pay return shipping costs.

Hardware Warranty Limitations

This warranty applies only to the ADI hardware specified in this document and used under normal operating conditions and within specification. Consumables, electrodes and accessories are not covered by this warranty. Third party equipment may be covered by the third party manufacturer's warranty. To the extent that ADI has the right to pass through any third party manufacturer warranties to Purchaser it will do so to the extent it is

able to do so. Copies of applicable third party manufacturer warranties, to the extent they exist, are available upon request. The warranty provided hereunder does not cover hardware modified in any way, subjected to unusual physical, electrical or environmental stress, used with incorrectly wired or substandard connectors or cables, or with the original identification marks altered. Tampering with or breaking of the Warranty Seal will also void the warranty.

Product Types & Warranty Term

ADI manufactured products covered by five (5) year warranty

¹ Data Acquisition Units: PowerLab 35 series with PL prefix

² Front-ends: ADI Front-end Signal Conditioners with FE prefix.

ADI manufactured products covered by three (3) year warranty

³ Data Acquisition Units: PowerLab 26 series with ML prefix

⁴ Front-ends: ADI Front-end Signal Conditioners with ML prefix.

⁵ Pods: The entire range of ADI Pod Signal Conditioners.

ADI manufactured products covered by one (1) year warranty

⁶ Specialized Data Recorders: Metabolic Systems (e.g. ML240 PowerLab/8M Metabolic System)

⁷ Instruments: Blood FlowMeter, Gas Analyzers, NIBP System (excluding transducers), STH Pump Controller.

Third Party Products (Including Transducers)

Products not manufactured by ADI are covered by the manufacturer's warranty.

Accessories and Consumables

Accessories and Consumables are not covered by any type of warranty.

General Limitations

ADI products are produced to high standards, and should perform as described in the supplied documentation. There is a limited hardware warranty, and technical support is provided for all ADI products. Nevertheless, since ADI products could be affected by external factors (for instance, the computer system on which they run and other hardware and/or software provided by third parties), absolute performance and reliability of products and the overall solution cannot be guaranteed. No warranty, either expressed or implied or statutory, other than that expressly contained in this Agreement, is made in respect to ADI products or software, third party products or software, the overall solution or otherwise. The Purchaser therefore assumes all risks as to the performance and reliability of the products, the software, the solution and the results gained using them. ADI neither assumes or authorizes any person to assume on its behalf any liability in connection with the sale, installation, service or use of its products. ADI shall not be held responsible for special, consequential or punitive damages of any kind arising out of sale, installation service or use of its products.

EXCEPT FOR THE EXPRESS WARRANTY SET FORTH HEREIN, THE SOLUTION AS WELL AS ALL EQUIPMENT AND SOFTWARE PROVIDED HEREUNDER ARE PROVIDED "AS IS" AND ADI MAKES NO WARRANTY AS TO ITS USE OR PERFORMANCE. EXCEPT FOR ANY WARRANTY, CONDITION, REPRESENTATION OR TERM THE EXTENT TO WHICH CANNOT BE EXCLUDED OR LIMITED BY APPLICABLE LAW, ADI AND ITS SUPPLIERS MAKE NO WARRANTY, CONDITION, REPRESENTATION, OR TERM (EXPRESS OR IMPLIED, WHETHER BY STATUTE, COMMON LAW, CUSTOM, USAGE OR OTHERWISE) AS TO ANY MATTER INCLUDING, WITHOUT LIMITATION, NONINFRINGEMENT OF THIRD PARTY RIGHTS, MERCHANTABILITY, INTEGRATION, OR FITNESS FOR A PARTICULAR PURPOSE. YOU ASSUME RESPONSIBILITY FOR SELECTING THE SOLUTION TO ACHIEVE YOUR INTENDED RESULTS, AND FOR THE INSTALLATION OF, USE OF, AND RESULTS OBTAINED FROM THE EQUIPMENT AND SOFTWARE. WITHOUT LIMITING THE FOREGOING PROVISIONS, ADI MAKES NO WARRANTY THAT THE EQUIPMENT OR SOFTWARE WILL BE ERROR-FREE OR FREE FROM INTERRUPTIONS OR OTHER FAILURES OR THAT THE SOFTWARE OR EQUIPMENT WILL MEET YOUR REQUIREMENTS.

UNDER NO CIRCUMSTANCES AND UNDER NO LEGAL THEORY, WHETHER IN TORT, CONTRACT, OR OTHERWISE, SHALL ADI OR ITS SUPPLIERS BE LIABLE TO PURCHASER OR TO ANY OTHER PERSON FOR LOSS OF PROFITS, LOSS OF GOODWILL, OR ANY INDIRECT, SPECIAL, INCIDENTAL, OR CONSEQUENTIAL DAMAGES, OR DAMAGES FOR GROSS NEGLIGENCE OF ANY

CHARACTER INCLUDING, WITHOUT LIMITATION, DAMAGES FOR LOSS OF GOODWILL, WORK STOPPAGE, COMPUTER FAILURE OR MALFUNCTION, OR FOR ANY OTHER DAMAGE OR LOSS. IN NO EVENT SHALL ADI OR ITS SUPPLIERS BE LIABLE FOR ANY DAMAGES IN EXCESS OF THE PRICE PAID FOR THE EQUIPMENT AND SOFTWARE, EVEN IF ADI, OR ITS AUTHORIZED PARTNERS OR SUPPLIERS HAVE BEEN ADVISED OF THE POSSIBILITY OF SUCH DAMAGES.

ADI is acting on behalf of its suppliers for the purpose of disclaiming, excluding and/or limiting obligations, warranties and liability as provided in this agreement, but in no other respects and for no other purpose. The foregoing provisions shall be enforceable to the maximum extent permitted by applicable law.

Controlling Law and Severability

This license shall be governed by the laws of the territory into which the software is sold, or if sold into the United States of America, by the laws of the State of California.

Technical Support

The Purchaser is entitled to free technical support for any ADI product for one year from its date of purchase. Our technical support staff can provide advice concerning installation and operation of ADI products. Services outside of this may incur a charge. Technical support staff will not provide experimental protocols or procedural instructions for conducting experiments. However, information of this type may be provided in the supplied product documentation, or on ADI web sites.

Inquiries

For additional information or service inquiries please contact the nearest ADInstruments office or Authorized Distributor. For contact details see ADInstruments.com

Copyright © ADInstruments NZ Ltd, 2020. All rights reserved. PowerLab, LabChart and ADInstruments are registered trademarks of ADInstruments NZ Ltd. Windows 8, Windows 7, Windows Vista and .NET Framework are trademarks of Microsoft Corporation. Apple, the Apple logo, MacOS, and Macintosh are trademarks of Apple Computer Inc. registered in the U.S. and other countries. Acrobat and Adobe are registered trademarks of Adobe Systems Incorporated. Igor is a trademark of Wavemetrics Inc. MATLAB is a registered trademark of The MathWorks Inc. Grass is a trademark of Astro-Med Inc. All other trademarks are the property of their respective owners.

Index

A

adjusting pressure 15
Adjust/Measure switch 17
analog outputs 16

B

back panel 16
BNC socket
 Flow Out 16
 Pressure In 16

C

calibrating
 flow signal 24–25
 pressure signal 25
checking the STH Pump Controller 14
circuit principles 30
cleaning 10
connecting
 third party bridge amps 21
 to Bridge Amp 20
 to external pumps 21
 to PowerLab 20
constant pressure mode 15

F

Flow Out BNC socket 16
Flow rate low-pass filter switch 17
Forward/reverse switch 15
Front panel 14

G

Gain Adj. control 17, 26

H

hold button 15
how it works 30
 constant flow mode 30
 constant pressure mode 31

I

I²C Input and Output 16
internal gain adjustment 17, 26

M

maintenance 10

P

power indicator 15
power-up test 21
pressure
 Adjust knob 15
 Hold button 15
 Set flow 15
pressure gain adjustment 17
Pressure In BNC socket 16
Pump DIN connector 17
Pump speed control 27

R

Run/Stop switch 15

S

Safety Notes 5–11
Set Flow knob 15
Specifications 33–34
Storage 11

T

testing the system 23

U

user modification voids warranty 29

using this guide 14