

Blood FlowMeter

Laser Doppler Monitoring

Owner's Guide



This document was, as far as possible, accurate at the time of release. However, changes may have been made to the software and hardware it describes since then. ADInstruments NZ Limited reserves the right to alter specifications as required. Late-breaking information may be supplied separately.

Trademarks of ADInstruments

PowerLab®, LabChart® and ADInstruments® are registered trademarks of ADInstruments NZ Limited.

Other Trademarks

Apple, Mac and Macintosh are registered trademarks of Apple Computer, Inc.

Windows, Windows 7, Windows 8, Windows 10 and Windows Vista are either registered trademarks or trademarks of Microsoft Corporation.

All other trademarks are the property of their respective owners.

Document Number: 6377 Rev D, Date of issue: 06/20

Copyright © ADInstruments NZ Limited, 2020. All rights reserved. PowerLab, LabChart and ADInstruments are registered trademarks of ADInstruments NZ Limited. Windows 8, Windows 7, Windows 10, Windows Vista and .NET Framework are trademarks of Microsoft Corporation. Apple, the Apple logo, MacOS, and Macintosh are trademarks of Apple Computer Inc. registered in the U.S. and other countries. Acrobat and Adobe are registered trademarks of Adobe Systems Incorporated. Igor is a trademark of Wavemetrics Inc. MATLAB is a registered trademark of The MathWorks Inc. Grass is a trademark of Astro-Med Inc. All other trademarks are the property of their respective owners.

Web: www.adinstruments.com

Manufactured in Australia by:
ADInstruments (Sydney) Pty. Ltd.,
13/22 Lexington Drive
Bella Vista 2153 New South Wales

Technical Support: support.au@adinstruments.com

Contents

Safety Notes **5**

1 Introduction **13**

How to Use This Guide	14
Checking the Blood FlowMeter	14
The Blood FlowMeter	14
The Front Panel	14
Power Indicator	15
Probe Status Indicator	15
Probe Input Connector	15
The Back Panel	15
Probe Calibration Button	15
USB Port (LCC/Digital)	16
Signal Output Connectors (Analog)	16
Fan Outlet	16
DC Power Connector	16
Power Switch	16

2 Setting Up **17**

Connecting the Blood FlowMeter	18
Switching on the Blood FlowMeter	19
Connecting the Laser Doppler Probe	19
Probe Application	20
Temperature Warning	20
Probe Calibration	21
Using the Blood FlowMeter with LabChart	22
LDF Output Calibration	22
BSC Output Calibration	22
Removing the Probes	22
BSC Output Calibration	23
Removing the Probes	23

A Care and Maintenance	24
Care of the Blood FlowMeter	24
Storage	24
Cleaning.	24
Care of the Probes	24
Handling the Probes	24
Storing the Probes	25
Cleaning.	25
Disinfection.	26
Sterilization.	26
B Troubleshooting	28
C Technical Aspects	31
Laser Doppler Flowmetry.	32
LDF Theory	32
How it Works	33
Probe Operation.	34
What the Blood FlowMeter Measures	34
The Blood Perfusion Unit (BPU).	34
Zero BPU.	35
Motion Artifact Noise.	35
D Specifications	37
Doppler Flow Specifications.	37
Power Supply.	38
Physical Configuration	38
Index	39



Safety Notes

Statement of Intended Use

All products manufactured by ADInstruments are intended for use in teaching and research applications and environments only. ADInstruments products are NOT intended to be used as medical devices or in medical environments. That is, no product supplied by ADInstruments is intended to be used to diagnose, treat or monitor a subject. Furthermore no product is intended for the prevention, curing or alleviation of disease, injury or handicap.

Where a product meets IEC 60601-1 it is under the principle that:

- it is a more rigorous standard than other standards that could be chosen.
- it provides a high safety level for subjects and operators.

The choice to meet IEC 60601-1 is in no way to be interpreted to mean that a product:

- is a medical device.
- may be interpreted as a medical device.
- is safe to be used as a medical device.

Safety Symbols

Devices manufactured by ADInstruments that are designed for direct connection to humans are tested to IEC 601-1:1998 (including amendments 1 and 2) and 60601-1-2, and carry one or more of the safety symbols below. These symbols appear next to those inputs and output connectors that can be directly connected to human subjects.



BF symbol: Body-protected equipment

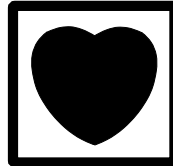

CF symbol: Cardiac-protected equipment



Warning symbol: See Documentation

The three symbols are:

- **BF (body protected) symbol.** This means that the input connectors are suitable for connection to humans provided there is no direct electrical connection to the heart.
- **CF (cardiac protected) symbol.** This means that the input connectors are suitable for connection to human subjects even when there is direct electrical connection to the heart.
- **Warning symbol.** The exclamation mark inside a triangle means that the supplied documentation must be consulted for operating, cautionary or safety information before using the device.

Further information is available on request.

Bio Amp Safety Instructions

The Bio Amp inputs displaying any of the safety symbols are electrically isolated from the mains supply in order to prevent current flow that may otherwise result in injury to the subject. Several points must be observed for safe operation of the Bio Amp:

- All Bio Amp front-ends (except for the FE138 Octal Bio Amp) and all PowerLab units with a built-in Bio Amp are supplied with a 3-lead or 5-lead Bio Amp subject cable and lead wire system. The FE138 Octal Bio Amp is supplied with unshielded lead wires (1.8 m). Bio Amps are only safe for human connection if used with the supplied subject cable and lead wires.

-
- All Bio Amp front-ends and PowerLab units with a built-in Bio Amp are not defibrillator-protected. Using the Bio Amp to record signals during defibrillator discharges may damage the input stages of the amplifiers. This may result in a safety hazard.
 - Never use damaged Bio Amp cables or leads. Damaged cables and leads must always be replaced before any connection to humans is made.

Isolated Stimulator Safety Instructions

The Isolated Stimulator outputs from a front-end signal conditioner or a PowerLab with a built-in isolated stimulator are electrically isolated. However, they can produce pulses of up to 100 V at up to 20 mA. Injury can still occur from careless use of these devices. Several points must be observed for safe operation of the Isolated Stimulator:

- The Isolated Stimulator output must only be used with the supplied bar stimulus electrode.
- The Isolated Stimulator output must not be used with individual (physically separate) stimulating electrodes.
- Stimulation must not be applied across the chest or head.
- Do not hold one electrode in each hand.
- Always use a suitable electrode cream or gel and proper skin preparation to ensure a low-impedance electrode contact. Using electrodes without electrode cream can result in burns to the skin or discomfort for the subject.
- Subjects with implantable or external cardiac pacemakers, a cardiac condition, or a history of epileptic episodes must not be subject to electrical stimulation.
- Always commence stimulation at the lowest current setting and slowly increase the current.
- Stop stimulation if the subject experiences pain or discomfort.
- Do not use faulty cables, or those that have exhibited intermittent faults.
- Do not attempt to measure or record the Isolated Stimulator waveform while connected to a subject using a PowerLab input or any other piece of equipment that does not carry the appropriate safety symbol (see Safety Symbols above).

Always check the status indicator on the front panel. It will always flash green each time the stimulator delivers a current pulse. A yellow flash indicates an ‘out-of-compliance’ (OOC) condition that may be due to poor electrode contact or electrode cream drying up. Always ensure that there is good electrode contact at all times. Electrodes that are left on a subject for some time need to be checked for dry contacts. An electrode impedance meter can be used for this task.

- Always be alert for any adverse physiological effects in the subject. At the first sign of a problem, stimulation must be stopped, either from the software or by flicking down the safety switch on the front panel of any built-in Isolated Stimulator or the FE180 Stimulus Isolator.
- The FE180 Stimulus Isolator is supplied with a special transformer plug pack. The plug pack complies with medical safety requirements. Therefore, under no circumstances should any other transformer be used with the Stimulus Isolator. For a replacement transformer plug pack please contact your nearest ADInstruments representative.

General Safety Instructions

To achieve the optimal degree of subject and operator safety, consideration should be given to the following guidelines when setting up a PowerLab system either as stand-alone equipment or when using PowerLab equipment in conjunction with other equipment. Failure to do so may compromise the inherent safety measures designed into PowerLab equipment.

The following guidelines are based on principles outlined in the international safety standard IEC60601-1-1: *General requirements for safety - Collateral standard: Safety requirements for medical systems*. Reference to this standard is required when setting up a system for human connection.

PowerLab systems (and many other devices) require the connection of a personal computer for operation. This personal computer should be certified as complying with IEC60950 and should be located outside a 1.8 m radius from the subject (so that the subject cannot touch it while connected to the system). Within this 1.8 m radius, only equipment complying with IEC60601-1 should be present. Connecting a system in this way obviates the provision of additional safety measures and the measurement of leakage currents.

Accompanying documents for each piece of equipment in the system should be thoroughly examined prior to connection of the system.

While it is not possible to cover all arrangements of equipment in a system, some general guidelines for safe use of the equipment are presented below:

- Any electrical equipment which is located within the SUBJECT AREA should be approved to IEC60601-1.
- Only connect those parts of equipment that are marked as an APPLIED PART to the subject. APPLIED PARTS may be recognized by the BF or CF symbols which appear in the Safety Symbols section of these Safety Notes.
- Only CF-rated APPLIED PARTS must be used for direct cardiac connection.
- Never connect parts which are marked as an APPLIED PART to those which are not marked as APPLIED PARTS.
- Do not touch the subject to which the PowerLab (or its peripherals) is connected at the same time as making contact with parts of the PowerLab (or its peripherals) that are not intended for contact to the subject.
- Cleaning and sterilization of equipment should be performed in accordance with manufacturer's instructions. The isolation barrier may be compromised if manufacturer's cleaning instructions are not followed.
- The ambient environment (such as the temperature and relative humidity) of the system should be kept within the manufacturer's specified range or the isolation barrier may be compromised.
- The entry of liquids into equipment may also compromise the isolation barrier. If spillage occurs, the manufacturer of the affected equipment should be contacted before using the equipment.
- Many electrical systems (particularly those in metal enclosures) depend upon the presence of a protective earth for electrical safety. This is generally provided from the power outlet through a power cord, but may also be supplied as a dedicated safety earth conductor. Power cords should never be modified so as to remove the earth connection. The integrity of the protective earth connection between each piece of equipment and the protective earth should be verified regularly by qualified personnel.
- Avoid using multiple portable socket-outlets (such as power boards) where possible as they provide an inherently less safe environment with respect to electrical hazards. Individual connection of each piece of equipment to fixed mains socket-outlets is the preferred means of connection.

If multiple portable socket outlets are used, they are subject to the following constraints:

- They shall not be placed on the floor.
- Additional multiple portable socket outlets or extension cords shall not be connected to the system.
- They shall only be used for supplying power to equipment which is intended to form part of the system.

Cleaning and Sterilization

ADInstruments products may be wiped down with a lint free cloth moistened with industrial methylated spirit. Refer to the Data Card supplied with transducers and accessories for specific cleaning and sterilizing instructions.

Preventative Inspection and Maintenance

PowerLab systems and ADInstruments front-ends are all maintenance-free and do not require periodic calibration or adjustment to ensure safe operation. Internal diagnostic software performs system checks during power up and will report errors if a significant problem is found. There is no need to open the instrument for inspection or maintenance, and doing so within the warranty period will void the warranty.

Your PowerLab system can be periodically checked for basic safety by using an appropriate safety testing device. Tests such as earth leakage, earth bond, insulation resistance, subject leakage and auxiliary currents and power cable integrity can all be performed on the PowerLab system without having to remove the covers. Follow the instructions for the testing device if performing such tests.

If the PowerLab system is found not to comply with such testing you should contact your PowerLab representative to arrange for the equipment to be checked and serviced. Do not attempt to service the device yourself.

Environment

Electronic components are susceptible to corrosive substances and atmospheres, and must be kept away from laboratory chemicals.

Storage Conditions

- Temperature in the range 0–40 °C
- Non-condensing humidity in the range 0–95%.

Operating Conditions

- Temperature in the range 5–35 °C
- Non-condensing humidity in the range 0–90%.

Disposal

- Forward to recycling center or return to manufacturer.
- Unwanted equipment bearing the Waste Electrical and Electronic Equipment (WEEE) Directive symbol requires separate waste collection. For a product labeled with this symbol, either forward to a recycling center or contact your nearest ADInstruments representative for methods of disposal at the end of its working life.



WEEE Directive
symbol

1

Introduction

The ADInstruments Blood FlowMeter is one of a family of stand-alone instruments, designed to measure blood cell perfusion levels in the microcirculatory beds of skin and other tissues. This Blood FlowMeter is LabChart compatible (LCC), which means it can be used directly with LabChart acquisition and analysis software, in addition to an analog recording via a PowerLab data acquisition unit.

This owner's guide covers the features of the Blood FlowMeter, its operation, maintenance and safety information.

How to Use This Guide

This owner's guide describes how to set up and begin using your Blood FlowMeter. Topics discussed included how to connect the hardware, perform a simple power-up test and calibration of the Blood FlowMeter. The appendices provide technical information about the Blood FlowMeter and look at some potential problems and their solutions. There is an index at the end of this guide.

Checking the Blood FlowMeter

Before connecting the Blood FlowMeter to anything, check it carefully for signs of physical damage.

1. Check that there are no obvious signs of damage to the outside of the Blood FlowMeter casing.
2. Check that there is no obvious sign of internal damage, such as rattling. Pick up the Blood FlowMeter, tilt it gently from side to side, and listen for anything that appears to be loose.

If you have found a problem, contact your authorized ADInstruments representative immediately, and describe the problem so arrangements can be made to replace or repair the unit.

The Blood FlowMeter

The remainder of this chapter contains general information about the features, connections, and indicators of the Blood FlowMeter. More detailed information can be found in Appendix C.

The Front Panel

Figure 1–1
Front panel of the
Blood FlowMeter

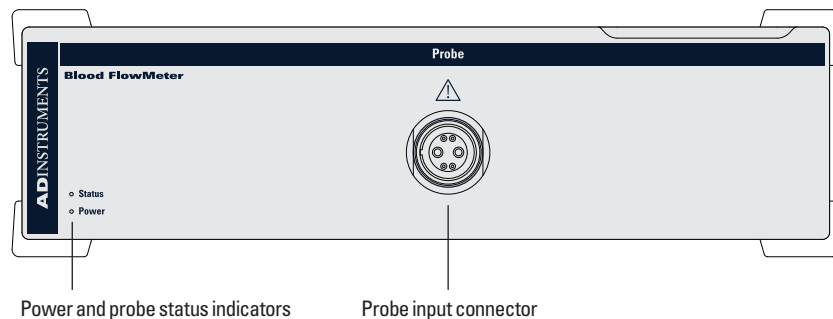

Power Indicator

The power indicator is located at the bottom left of the front panel. When lit, it indicates that the Blood FlowMeter has power from the external power supply.

Probe Status Indicator

The probe input has an associated Status indicator. This indicator is used to indicate what is happening to the channel at any given time. Flash and color indications are listed below:

- Green (continuous): Channel OK — no probe connected
- Red/Amber (flashing): Calibration in progress
- Amber (continuous): Probe connected and laser operating

Probe Input Connector

The Blood FlowMeter is a single channel device and provides one probe input connector. The input connector is a polarized (keyed) multi-pin connector with optical interfaces for the fiber optics in the probe cable. The probes are designed to push and click into the connector. Do not touch or tamper with any part of the connector as it may damage the optics or internal circuitry.

The Back Panel

Figure 1–2
The back panel of the
Blood FlowMeter

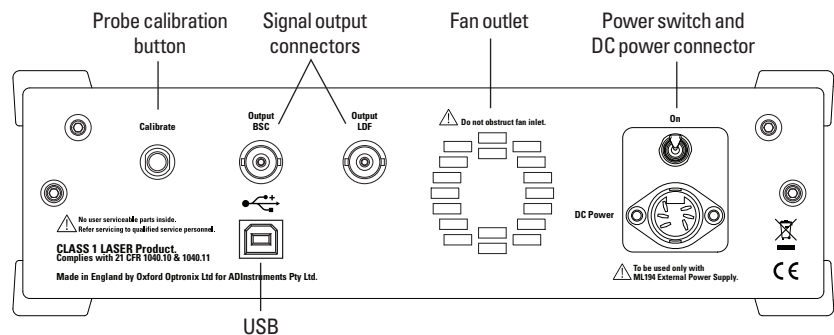

Probe Calibration Button

The Blood FlowMeter is designed to automatically configure and calibrate itself for specific probes. This operation requires a MLA191 Calibration Kit, which includes a controlled concentration of latex spheres in suspension. This is discussed in Probe Calibration, page 21.



USB icon and port

USB Port (LCC/Digital)

The Blood FlowMeter has a USB port, which connects to a computer with USB ports or a PCI USB card installed, allowing high data transfer rates with LabChart software. Your Blood FlowMeter is supplied with a high-speed USB cable. For proper use and reliable results, the Blood FlowMeter needs a high-speed USB connection. In practical terms this means cables between any USB devices must be no more than 5 meters (16 feet) in length. If you replace the USB cable, buy a high-speed cable (fully shielded, twisted-pair and standard USB connections: a narrow rectangular plug at one end and a square plug with a bevelled top at the other).

Signal Output Connectors (Analog)

There are two BNC output connectors on the back panel. All signals are analog and are designed to be suitable for connection to a variety of data recording systems, particularly PowerLabs.

The signal from the Output BSC represents the percentage backscatter (tissue remittance). It has a range of 0–5 V (1% remittance is 50 mV).

The Output LDF provides the laser Doppler flowmetry output signal, in the range 0–5 V. This signal represents the relative Blood Perfusion with 1 perfusion unit equalling 1 mV.

Fan Outlet

In order to maintain the internal laser diode temperature, the Blood FlowMeter utilizes a thermostatically controlled fan to supplement cooling when required. The fan outlet must remain clear of obstructions during operation.

DC Power Connector

Power to the Blood FlowMeter comes from an external, medically rated, power supply (provided with the Blood FlowMeter). The power supply unit is designed to connect to a wide variety of AC supplies. Connection of power to the Blood FlowMeter is via a mini DIN connector. All power at this point is low voltage.

Warning

The Blood FlowMeter's medical rating is only valid when used in conjunction with the power supply provided. Using any other type of supply will not guarantee medical approval.

This chapter guides you through connecting your Blood FlowMeter and subsequent operation of the instrument. The Blood FlowMeter may either interface directly to LabChart software (digital) and/or to a PowerLab data acquisition unit (analog). Direct interfacing to LabChart requires installation of both ADInstruments LabChart and Blood FlowMeter Device Enabler software first. You should read this chapter carefully before using your Blood FlowMeter.

Install ADInstruments Software

Please follow the instructions below in the correct order.

First, install ADInstruments LabChart software

You should first install the appropriate LabChart version for Windows or Macintosh on your computer. Place the LabChart CD in the CD drive of your computer. The installer should auto-run. If it doesn't, see the Read Me on the CD. Follow the onscreen instructions.

Next, install the Blood FlowMeter Device Enabler

The Blood FlowMeter Device Enabler is a software add-on for LabChart software.

Place the CD for the ADInstruments Blood FlowMeter Device Enabler in the CD drive of your computer. The installer should auto-run. Follow the on-screen instructions. Alternatively, download the Device Enabler via LabChart Feature Manager or ADInstruments website.



Connecting the Blood FlowMeter

Before connecting anything make sure that the power outlet and the switch on the rear panel of the Blood FlowMeter are turned off.

Connect the power supply output of the external supply to the power input of the Blood FlowMeter. Make sure that this connector is pushed all the way in, as it does not have a locking facility.

USB Connection (Digital)

When you have installed the software, connect the Blood FlowMeter to your PC or laptop using the USB cable supplied with the device.

Figure 2-1
Connecting a Blood FlowMeter to a computer with USB

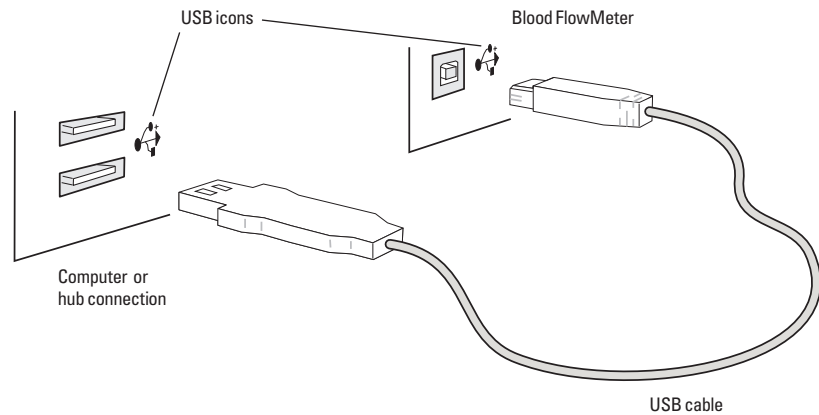

Note: Windows may display a message to indicate that the device driver is being installed when the Blood FlowMeter is turned on.

BNC Connection (Analog)

Connect the BNC outputs of the Blood FlowMeter to the signal inputs of your recording device. Note that the Blood FlowMeter has outputs for both LDF and BSC signals (see Signal Output Connectors, page 16). Both signal outputs do not need to be used. You only need to connect the output signal that you wish to record.

Switching on the Blood FlowMeter

When the power has been connected, turn on the power switch on the rear panel of the Blood FlowMeter. The Power indicator on the front of the Blood FlowMeter should glow green and you should hear a double beep from the unit to indicate that it has initialized.

Connecting the Laser Doppler Probe

Very carefully remove the probe from its protective case and check that the probe connector is clean and free from dust. To connect the probe to the probe connector on the front of the Blood FlowMeter, orientate the plug with respect to the socket until it is aligned correctly. The socket is designed to only accept the plug in one particular orientation. Once aligned, carefully push the plug into the socket until locked in position.

If everything is OK then the status indicator for the probe will glow amber. If there is something wrong with the probe or connection then the status indicator will remain green.

Wait at least ten minutes before making any measurements to allow the instrument's temperature to stabilize. Please note that temperature 'out-of-range' beeps may occur during the warm-up period.

Probe Application

Warning: Needle (implantable) laser Doppler probes are ONLY for use in animals. Only surface laser Doppler probes are safe for use on humans.

Surface probes can be attached to tissue using a self adhesive ring. These have adhesive on both sides with a small hole in the center. Needle probes can be secured by using a micro-manipulator or some similar device.

It is important to control the relative movements of the tissue (especially that induced by breathing) with respect to the probe. Relative movements will produce artifacts in the perfusion signal. These can be reduced by allowing the supported probe to lightly contact the surface of the tissue. Under some conditions it may be desirable for the probe to be held in position by hand. It is essential to ensure that the pressure on the tissue is minimal, otherwise local occlusion of the microvasculature may result.

Excessive ambient lighting at the probe site can disturb the blood perfusion reading. Avoid direct illumination of the measurement site, especially direct sunlight. If erroneous readings of the measurement site from external lighting levels are suspected, cover the attached probe and measurement area with a light piece of opaque material.

Probe signal outputs for different conditions are listed in Table 2-1.

Table 2-1
Probe outputs for
different conditions

<i>Condition</i>	<i>LDF</i>	<i>Backscatter</i>
No probe	-2.5 V (-2500 BPU)	0 V (0 %)
Unrecognized probe	-5 V (-5000 BPU)	-5 V (-100 %)
Low backscatter	0 V (0 BPU)	-2.5 V (-50 %)
Flow over range	+5 V (+5000 BPU)	+5 V (+100 %)

Temperature Warning

If the internal temperature of the Blood FlowMeter moves outside the operating temperature range of the device, then it will emit a double beep every 16 seconds. If this occurs, the instruments should be moved to a cooler environment for proper operation.

With the temperature out of range, output signals will continue to be generated but may no longer be within the calibrated tolerance of the system and should be interpreted with caution. If there are any problems or faults please contact your ADInstruments representative for further advice.

Probe Calibration

The Blood FlowMeter is designed to be easily configured and calibrated for new probes. This operation requires a MLA191 Calibration Kit, which includes a controlled concentration of latex spheres in suspension. It is important to follow the instructions provided with the Calibration Kit as calibration of probes is not possible without it and should not be attempted.

Before starting this it is advisable to have a stable workbench free from vibration. A clamp to hold the probe reliably in the suspension is provided in the calibration kit. Set up the probe in the center of the suspension, with the measuring surface of the probe at a maximum distance from all edges of the vessel. Follow the procedure below to calibrate the probe. Note that calibration can be abandoned at any time by removing the probe or by pressing the CAL button during the calibration.

1. Ensure the probe has been properly initialized for at least 10 minutes prior to attempting the calibration (see Connecting the Laser Doppler Probe, p. 18).
2. Using the positioning clamps provided with the MLA191 Calibration Kit, immerse the probe to mid-depth in the calibration solution.
3. Press the CAL button once. A single beep is emitted, followed by a series of double beeps, lasting approximately 20 seconds.
4. While the beeping continues, press the CAL button once. A long beep will sound and the red and amber lights will flash for approximately 25 seconds.
5. A double beep will sound to indicate the end of the calibration, confirming the calibration. After five seconds, the red indicator light returns to amber and the unit is ready for use.

During calibration keep the bench free of vibration and movement as this may invalidate the result. Generally a probe does not require recalibration unless a new or replacement probe is introduced.

Using the Blood FlowMeter with LabChart

The Blood FlowMeter has been designed to be used with either directly (USB connection) with LabChart software and/or with the ADInstruments PowerLab system, or any analog recording device such as a paper chart recorder (BNC Connection).

The units and recording settings (i.e. range, sampling rate) are set automatically when interfacing directly to LabChart software via the Blood FlowMeter Device Enabler software.

The following sections describe how to use the Blood FlowMeter with a PowerLab data acquisition unit (BNC connection) and LabChart software. It is assumed that you know how to connect the Blood FlowMeter to your PowerLab system and that you are familiar with the LabChart software.

LDF Output Calibration

Both the LDF and BSC outputs have been factory calibrated to give a certain voltage output per calibrated unit. The LDF output produces 1 mV for each blood perfusion unit. As the maximum output of the Blood FlowMeter is 5000 perfusion units or 5 V, you should set the range of the corresponding input in LabChart to 5 V, or more sensitively depending on your requirements. As LDF output only produces an output in the range 0 – 5 V, you can also set the Amplitude axis scale to single-sided for the LabChart channel.

To calibrate the system, open the Input Amplifier dialog for the LDF channel. Click the **Units...** button to open the Units Conversion dialog.

At the top of the dialog type in the values shown in Figure 2–2. Note that you must enter the numbers on the left as mV in order to get the correct scaling. You can define a suitable unit name, for example ‘Perf Unit’, by selecting **Define Unit...** in the Units drop-down list. Click **OK** to make sure that the units conversion is applied to that channel. Check to see if it has been applied by looking at the scale of the Input Amplifier dialog.

Figure 2–2
Entering units conversion
information for the LDF
channel

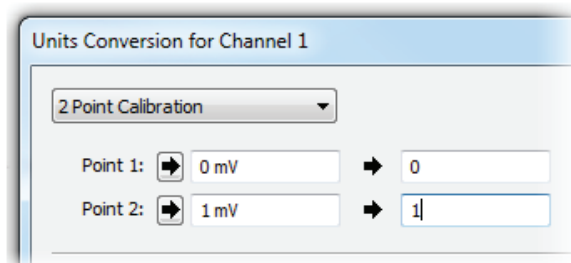
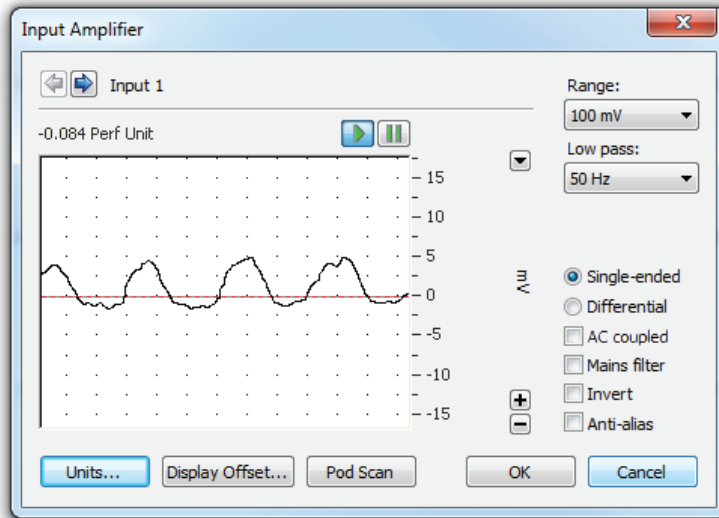

Figure 2-3
Amplifier dialog once LDF
waveform conversion has
been applied

An example of what you should see is shown in Figure 2-3. This figure also shows a typical waveform from the LDF output. You can use a **Low pass** filter setting to remove any unwanted noise. You should not use the **AC coupled** feature as this will result in an incorrect measurement of blood perfusion units.



BSC Output Calibration

Calibrating the BSC channel is a similar process to that for the LDF output, but with different values required. As the BSC output represents the relative strength of the returned signal, it is a voltage that represents the percentage of backscattered light. A 100% backscattered signal is represented by a voltage of 5 V. Zero backscattering corresponds to 0 V. This gives an output that corresponds to 50 mV per % backscattering.

Removing the Probes

To remove a probe from the instrument, gently pull the outside of the probe connector (the knurled sleeve). This will disengage the locking mechanism and the connector should just pull out. Do not attempt to force the connector.

A

Care and Maintenance

Care of the Blood FlowMeter

Storage

When not in use, the Blood FlowMeter should be stored at room temperature, although it may be stored at temperatures in the range of 5 – 50 °C. When returning from extremes of temperature, it is important to allow the instrument to stabilize at room temperature before use.

Cleaning

Warning: Do not spray, pour or spill any liquid on the Blood FlowMeter, its accessories, connectors, switches or openings in the enclosure. Do not submerge the instrument in liquid.

To clean the outside cover of the Blood FlowMeter or to remove spills, wipe the device with a soft, lint free cloth. Do not use alcohol or abrasive-based cleaners as this may damage the external surfaces of the device.

Care of the Probes

Handling the Probes

Caution: Probes for the Blood FlowMeter must be handled with care. Failure to do this may result in breakage of the internal optical fibers, scratching the polished probe ends or separation of the cable from the probe ends or connectors.

The optical fibers used in the probes are glass and have a diameter of 125 μm . Although the fibers are flexible and can be bent, it is recommended that they are not subjected to bends with a radius less than 30 mm.

The probe connectors must be kept clean and free from dust. Connectors should be inspected before each use. Dust can be removed from the connectors using an air-duster.

The integrity of probes may be checked by holding the probe end to a source of bright diffuse light, for example a lamp, and inspecting the connector end. Two bright spots of light of equal intensity should be visible from the pins within the connector.

Storing the Probes

When not in use, probes should be stored either in the probe box or, following sterilization, stored unopened in the packaging in which they were sterilized.

Probes should be stored with the optical fiber coiled neatly.

Cleaning

Probes are cleaned prior to packing and dispatch. It is recommended that the probe end on all new probes be wiped with a soft cloth, preferably one that does not shed fibers, impregnated with 70% alcohol in water.

It is recommended that after use probes are cleaned immediately as it is easier to remove soiling and particulate matter before it dries onto the probe surfaces.

1. Visually inspect the probe end, cable and connector. If there is no visible soiling, wipe the probe end and cable with a soft cloth impregnated with 70% alcohol in water. Allow the alcohol to dry completely before using the probe.
2. If there is visible soiling, clean the probe with warm water containing a mild detergent.
3. Careful rubbing with a soft cloth or brush should be employed to ensure that all soiling and particulate matter is removed. These actions should be carried out beneath the surface of the cleaning solution.

Note: Avoid immersing the probe connector in the cleaning solution.

4. Rinse the probe end and cable in clean water.
5. Wipe the probe end and cable with an absorbent cloth and leave the probe to dry completely.

Disinfection

Probes can be disinfected by immersion of the probe end and cable in:

- 2% glutaraldehyde, or
- 70% alcohol in water

The disinfectant manufacturer's recommended immersion times should be used.

Sterilization

Only some of the dedicated perfusion probes may be sterilized by moist heat (steam). For further details please contact your ADInstruments representative.

B

Troubleshooting

This appendix describes some problems that may arise when using the Blood FlowMeter. If you have any trouble getting the Blood FlowMeter to work, use this section to try and isolate and fix the problem. If you cannot find a solution to your problem in this appendix, or in the appendices of your PowerLab hardware and software guides, please contact your ADInstruments representative.

Although the Blood FlowMeter has been designed to be very reliable, there may be occasions when it does not appear to function correctly. In the majority of cases, the problem can be fixed by checking connections and or resetting the Blood FlowMeter. Very rarely will there be an actual problem with the Blood FlowMeter. This appendix will help you to determine what kind of fault you have and an appropriate solution.

The Power indicator fails to light when the unit is turned on

The power is switched off at the wall, the power cable is not connected firmly, or a fuse has blown.

- Check switches, power connections, and fuses.

The power cable from the external power supply is loose.

- Check that the power supply cable is firmly connected to the power input connector on the back of the Blood FlowMeter.

A faulty power supply unit.

- If you suspect the power supply unit or the Blood FlowMeter itself then contact your ADInstruments representative for advice. Do not attempt to fix these components yourself as it will void the warranty and may compromise the safety aspects of the system.

The Power indicator is lit but the Status indicator does not light when the probe is plugged in

A faulty or damaged probe connector.

- Check that all the connection pins are straight. If one or more is bent do not attempt to bend them back. Contact your ADInstruments representative for help.

The Blood FlowMeter internal processor is not working.

- Turn off the power, wait five seconds and turn on the power again. If the Status indicator light still does not light then the main processor circuitry may be faulty. Contact your ADInstruments representative for help.

The Blood FlowMeter does not produce any laser output when the power is on

A faulty probe connection.

- Make sure the probe is properly connected to the system by pushing its connector firmly into the front panel socket. If this fails to correct the problem, remove the probe and check the connector pins to verify that they are straight. If any of the pins are bent do not attempt to fix them, instead contact your ADInstruments representative for assistance.

A faulty optic fiber in the probe.

- If the probe cable has been subject to undue mechanical stress then the internal optic fiber could be damaged. Although this is unlikely, the probe should not be used in this case. A replacement will need to be purchased.

A faulty laser diode.

- This is very unlikely, but if everything else has been checked and there is still no laser output, then you should contact your ADInstruments representative for service.

There is no signal output from the Blood FlowMeter

No power to the Blood FlowMeter.

- Check that the Power indicator on the Blood FlowMeter is on.

The probe is not plugged in correctly.

- Check the probe is connected correctly.

A loose or missing output connection to your recording equipment.

- Make sure that the appropriate output signals from the Blood FlowMeter are connected properly to your recording equipment.

C

Technical Aspects

Blood flow in the skin performs an essential role in the regulation of the metabolic, hemodynamic and thermal state of the individual. Despite the fact that the skin is the body's largest and most accessible organ, the measurement of cutaneous microcirculatory blood perfusion has until quite recently proved a formidable task.

By far the largest proportion of the body's dermal vasculature is involved in regulating body temperature and controlling systemic blood pressure. A smaller but significant proportion of the bulk skin blood perfusion also fulfils the skin's metabolic requirements. It is the upper dermis (i.e the first 1.5–4.0 mm of tissue, depending on the site) that is chiefly responsible for providing a nutritional supply of blood to the avascular epidermis, the integrity of which is essential for the well-being of the individual. The degree of blood cell perfusion in this region of the microvascular tree, over both long and short time periods, can provide a reliable indicator of peripheral vascular disease or injury. Reduction or even complete occlusion of blood perfusion in the microcirculatory blood vessels can often be attributed to a variety of cutaneous vascularization disorders.

Laser Doppler Flowmetry

Laser Doppler flowmetry (LDF) offers a continuous measurement of blood cell perfusion in the microcirculatory beds of skin tissue and other tissues without influencing the blood perfusion. LDF is established as an effective and reliable clinical medicine and microvascular research technique. This has been achieved largely because LDF satisfies the need for continuous, non-invasive and real-time measurement of blood perfusion in the microvasculature.

Laser Doppler flowmeters produce an output signal that is proportional to the blood cell perfusion (or flux). This represents the transport of blood cells through microvasculature and is defined as:

$$\text{Microvascular Perfusion} = \text{number of blood cells} \times \text{mean velocity}$$

Microvascular perfusion, therefore, is the product of the mean cell velocity and mean blood cell concentration present in the small volume of tissue under illumination from the laser beam.

LDF Theory

LDF makes use of the fact that when tissue is illuminated by a coherent, low powered laser, light is scattered by both moving and static structures within the microcirculatory beds. Photons, scattered by moving blood cells are spectrally broadened according to the Doppler effect. Maximum Doppler shifts occur when blood cells are moving in a direction parallel to the incident light beam and the detected light (scattered light) from the cells is detected in a direction opposite to its origin. For example, a Doppler shift of about 4 kHz is obtained when laser light (of a wavelength of 830 nm) is backscattered from a particle in water moving at 1 mm/s parallel to the light beam. In general a continuous range of Doppler frequency shifts is expected. Photons scattered by static structures alone do not undergo Doppler shifting.

In order to detect these small frequency shifts it is necessary to use a technique called 'optical beating'. This basically means that the original output light is mixed with the backscattered light to effectively add the signals. (In technical terms this is referred to as heterodyning). When these signals are presented to the detector the result is an output which contains a fluctuating component related to the difference between the two beams.

This is performed using a photo diode detector. The frequency and magnitude of the alternating component of the photocurrent from this device (i.e. the power spectral density) is related to the mean velocity and concentration of blood cells present in the measuring volume.

The signal from the photodiode is converted to digital information and then processed using a DSP (Digital Signal Processor). This device performs the spectral analysis and produces an LDF signal.

How it Works

The Blood FlowMeter determines the blood flow perfusion by illuminating the surface of the skin with laser light and measuring the backscattered light. Various calculations are then performed on the returned signal which is then turned into a continuous signal that represents the blood perfusion in the illuminated area. The block diagram below shows a very basic outline of the fundamental components.

The input channel is supplied with laser light at a wavelength of 830 nm (visible red light) from an internal semiconductor laser diode which is temperature controlled by means of a Peltier cell and fans.

The laser light is transferred to the Probe connector by optic fiber.

Figure C-1
Block diagram of the
Blood FlowMeter

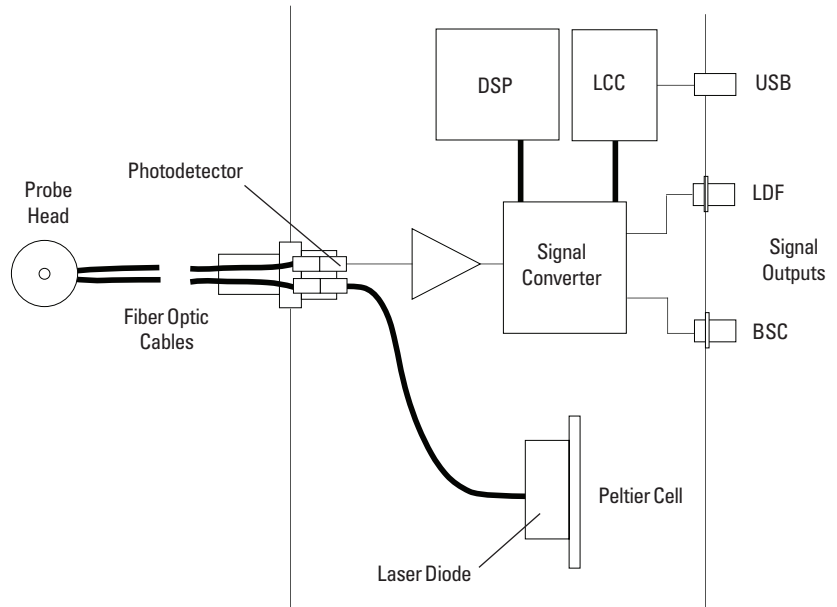

When the probe is connected the system will turn on the laser, therefore passing red light down the length of the probe's fiber optics to the probe head. The probe head has an optical lens that allows light to be transmitted to the skin surface as well as allowing the transmission of backscattered light via a separate optic fiber. The returned or backscattered light travels up to the probe cable to a photodiode assembly attached to the input connector. The photodiode generates an electrical signal proportional to the light it receives.

The returned signal will be a combination of the original light and backscattered light which results in a signal with a varying frequency content. This varying signal content is the signal of interest as it represents the Doppler shift as a result of light being backscattered off moving blood cells.

This photodiode signal is digitized and a digital signal processor is used to perform a spectral analysis of the signal to determine the mean velocity of the blood cells and thus generate an LDF signal. The result is converted back into an analog signal that is proportional to the blood perfusion in the area of measurement.

Probe Operation

There are several types of optic probes that can be used with the system, each one having its own optical characteristics. In order to make sure that different probes will produce consistent results, each probe contains a means of identifying itself to the system. In this way you can change probes without having to recalibrate your system.

What the Blood FlowMeter Measures

The Blood FlowMeter is a laser Doppler flowmeter whose primary purpose is to measure real-time microvascular red blood cell (RBC) perfusion (otherwise known as RBC flow or RBC flux). Laser Doppler signals are recorded in BPU which is a relative units scale defined using a carefully controlled motility standard.

The Blood Perfusion Unit (BPU)

The Blood FlowMeter has been factory calibrated with a constant, known motility standard so that, for a given perfusion situation, all probes will read the same value of BPU. However, it should be noted that BPU is not an intrinsic physiological definition of blood perfusion.

The notion of a universal physiological standard, valid for all types of tissue is scientifically inconceivable. Such activity rests on the assumption that microcirculatory blood perfusion is essentially homogeneous for all tissue structures over the human body. This assumption is seriously flawed due to

the regional complexity of the skin's microvasculature, its global variability over the human body, and the fact that the complex nature of light scattering in tissue makes LDF suitable for characterizing only relative changes in blood perfusion. So, although the Blood FlowMeter can be absolutely calibrated using an *in vitro* model, the complex and variable geometry of the vascular tree precludes absolute calibration for *in vivo* applications. This means that even though the Blood Perfusion Unit (BPU) can be traced to a physical standard, the measurements expressed in BPU must be considered as strictly relative.

Zero BPU

The zero reading of the Blood FlowMeter has been obtained by calibrating the system against a special static scattering material where no movements occur. In such cases the back-scattered light processed by the Blood FlowMeter contains no Doppler shifted frequencies and a true zero is obtained. A zero reading therefore indicates zero motion in the measuring volume under examination and also zero artifactual motion arising from relative movements between the probe and the measuring volume. During *in vivo* measurements an absolute zero is rarely obtained. Even during total occlusion of the tissue blood perfusion, there is often some small, residual motion of blood cells trapped in the vessels, as well as some small muscle and tissue movement in the measuring volume. Even after surgical removal of tissue, localized cell movement and Brownian motion may still occur in the severed blood vessels.

The Blood FlowMeter's internal software allows the zeroing of the laser Doppler signal when there is insufficient light returning from the tissue to the probe. In the default condition (power on), the cut-off threshold is set to 1%. This means that if the backscatter signal falls below 1%, the laser Doppler signal is automatically zeroed.

Motion Artifact Noise

Laser Doppler studies sometimes reveal changes in the blood perfusion signal which are often unrelated to actual physiological changes in blood perfusion. These artifacts in the blood perfusion signal can often be attributed to the movement of the optical fibers in the beam delivery/collection system and are noticeable in situations where the subject moves or twitches. This type of artifact may be worse in situations where the probe moves with respect to the tissue. This effect can therefore be minimized by using a probe which is connected to, rather than clamped over the tissue, for example by using the standard right angle or saturable probes.

Spurious motion artifact may occur when a ventilator, or other mechanical device is employed. Under these conditions, artifacts should be minimized by controlling vibration reaching the measurement site and the Blood FlowMeter. This may be achieved by placing the ventilator on a separate table and on a vibration absorbing medium.

D

Specifications

Doppler Flow Specifications

Mode:	Continuous laser Doppler flowmetry
Primary measurand:	Microvascular blood perfusion (Relative RBC Flux)
LDF units:	Relative units (0-5000 Blood Perfusion Units, corresponding to 0-5 V output)
BSC units:	Relative units (0-100% corresponding to 0-5 V output)
Laser type:	Semiconductor laser diode (temperature stabilized)
Laser wavelength:	830 nm \pm 10 nm
Laser power:	< 0.5 mW from probe
Laser class:	Class 1 (as per 21 CFR 1040-10 and 1040-11)
Doppler signal bandwidth:	16 kHz
Linearity range:	Up to 0.35% moving scatterers by volume
Flow response time:	< 0.2 s
Reading stability:	5% (measured with standard motility solution)
Zeroing:	Automatic, controlled

Flux calibration: Factory or user calibrated using a motility standard (concentration of latex spheres undergoing Brownian Motion)

Power Supply

Supply type: Power supply in external enclosure

Voltage range: 100-240 V AC (50-60 Hz), 0.8-0.4 A

Output power: + 5 V, ± 12 V DC

Fusing: Internal, 2 A 240 V resettable

Physical Configuration

Dimensions (h × w × d): 70 mm × 240 mm × 260 mm
(2.70" × 9.45" × 10.2")

Weight: 2.5 kg

Power requirements: 240 V or 120 V (internally set) @ 15 W

Operating temperature: 5-35 °C

Operating humidity: 0-70% (non-condensing)

ADInstruments reserves the right to alter these specifications at any time.

Index

A

artifacts 35

B

back panel 15

backscatter output 15

blood cell perfusion 32

Blood FlowMeter

checking for damage 14

cleaning 24

connecting to other equipment 18

operating principles 31

troubleshooting 28

Blood Perfusion Units 34

BPU

limitations 34

zero readings 35

BSC output 32

C

checking the Blood FlowMeter 14

cleaning 10, 24

connecting probes 18

connectors

back panel 15

front panel 14

power 16

probe input 15

signal output 15

USB 16

cooling requirements 16

D

Doppler effect 32

F

fan outlet 16

front panel 14

I

indicator lights

power 15

probe status 15

L

Laser Doppler Flowmetry 32

laser illumination 32

LDF output 32

LDF theory 32

M

maintenance 10

microvascular perfusion 32

motion artifacts 35

O

optic fiber 33

P

power indicator light 15

power supply socket 16

power switch 16

probe

connection 19

input connector 15

operation 34

removal 23

status indicator light 15

sterilization 26

storage 25

R

RBC 34

red blood cell perfusion 34

removing probes 23

S

Safety Notes 5–11

signal connection 18

signal outputs 15

sterilization of probes 26

storage 11

storage of probes 25

T

technical aspects 31

troubleshooting 28

U

using this guide 14

Z

zero BPU readings 35