

# Human NIBP Nano

Non-invasive hemodynamics

## Quick Start

Get set up and start recording





# Overview

This guide will help you to quickly set up the Human NIBP Nano System. For detailed installation and set up instructions and troubleshooting information, please refer to the **Owner's Guide** (also available at [www.adinstruments.com/support/manuals](http://www.adinstruments.com/support/manuals)).

The Human NIBP Nano System contains the following:

- Human NIBP Nano Wrist Unit
- Height Correction Unit
- LabChart Pro® and Human NIBP Device Enabler software CDs
- Human NIBP Nano Interface and USB cable and power cable

 The Human NIBP Nano Wrist Unit is manufactured by Finapres Medical Systems (FMS) B.V. ([www.finapres.com](http://www.finapres.com)) for distribution by ADInstruments, and for use with ADInstruments software. Finger cuffs are purchased separately:

- Finger Cuff (Large, for finger circumferences 65-75 mm)..... MLT382/L
- Finger Cuff (Medium, for finger circumferences 55-65 mm)..... MLT382/M
- Finger Cuff (Small, for finger circumferences 45-55 mm)..... MLT382/S

## System Requirements

### Windows

- A PC capable of running LabChart 8.1.8 or above. For detailed system requirements please see <https://www.adinstruments.com/support/system-requirements>.

### PowerLab not required

- An ADInstruments PowerLab is not required to use the Human NIBP Nano System with LabChart, but you can record data simultaneously into LabChart using a PowerLab and the Human NIBP Controller.

# What's in the box

The Human NIBP System consists of the following hardware components:

## The Human NIBP Nano Wrist Unit



- The Wrist unit is the core of the system. It has input connectors for up to 2 finger cuffs as well as a the HCU Unit. The long output cable connects the Human NIBP Nano Interface.

## Height Correction Unit (HCU)

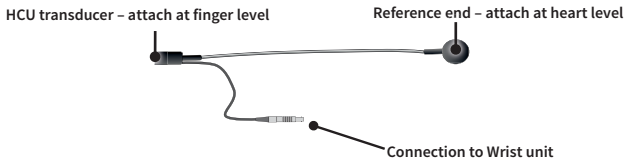

- This corrects for hydrostatic pressure changes when the measured hand moves away from heart level. The HCU consists of a liquid-filled tube connected at one end to a pressure transducer.

## Human NIBP Nano Interface

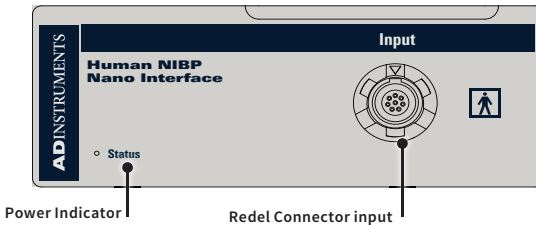

- The Human NIBP Nano Interface provides power and USB connectivity to the Wrist Unit. It has a Redel input at the front for connection to the wrist unit and an IEC power input and USB type B input at the rear. It is supplied with a USB cable and a power cable appropriate for your country.

# 1. Unpack the box

## Connect Wrist Unit to Interface

1. Ensure the Redel cable is connected securely to the front panel of the Human NIBP Nano Interface.

## Connect device to your computer

2. Connect the Human NIBP Nano Interface to your computer using the supplied USB cable.
3. Connect the power cord to a grounded power supply and to the rear panel of the Human NIBP Nano Interface.

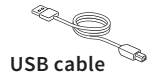

USB cable

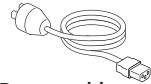

Power cable

## Power on the hardware

Turn on the Human NIBP Nano Interface using the power switch on the rear panel.

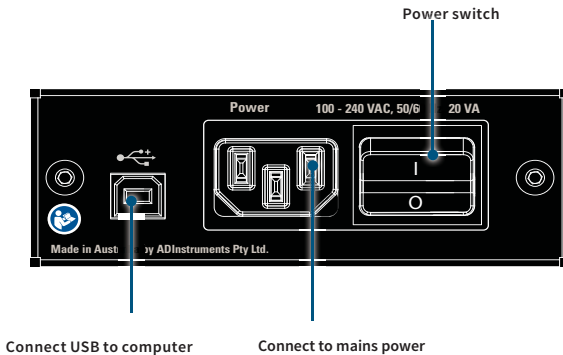

Connect USB to computer

Connect to mains power

## 2. Install software

The Human NIBP Nano System consists of the following software components:

### LabChart Pro®

1. Place the LabChart Pro CD in the CD drive of your computer. Alternatively you can download the latest version of LabChart from here (<https://www.adinstruments.com/support/downloads/windows/labchart>)
2. Follow the on-screen instructions to install LabChart 8.
3. Launch LabChart by double-clicking on the desktop icon. Enter the activation code when prompted.
4. Check for updates (**Help > Check for Updates...**) and install the latest LabChart



### Human NIBP Device Enabler CD

1. The Human NIBP Device Enabler is a software addition to LabChart. It is designed to allow LabChart to recognise the Human NIBP Controller, when it is connected to your computer, and to open LabChart with the appropriate settings to make non-invasive blood pressure measurements.
2. Place the Human NIBP Device Enabler CD in the CD drive of your computer. Alternatively you can download the latest version of the Human NIBP Device Enabler from here (<https://www.adinstruments.com/support/software>)
3. The installer should auto-run. If it doesn't, see the Read Me on the CD.
4. Alternatively, use LabChart's Feature Manager (**Help > Feature Manager...**) to download the latest installer.

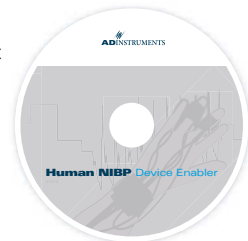

## 3. Start LabChart

### License Registration

1. When you start LabChart for the first time, a dialog will appear asking you to enter your license code. Your license code can be found on the LabChart CD case. If you purchased LabChart Pro then both codes on the back of your CD case should be entered in turn to unlock all the features of LabChart Pro.
2. Enter your license details.

### Device Discovery

On start-up, LabChart performs a Device Discovery process. It should automatically detect the Human NIBP Nano device. If it doesn't find the device immediately, click **Device Scan**, and then click **OK**.

**Note:** If this dialog persists, close down LabChart. Ensure the Human NIBP Nano is connected to your PC and powered on, then restart LabChart. If this doesn't resolve the problem, see the Troubleshooting section of the **Owner's Guide**.

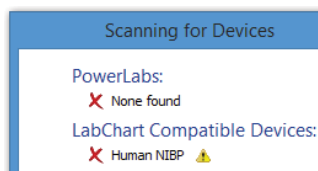

### License Activation

Activation is only required once per machine. If a supported PowerLab is already connected and turned on, your license will activate automatically. Otherwise, you may choose online or manual activation.

### Welcome to LabChart!

LabChart's Welcome Center opens automatically when LabChart is launched.

1. In the Getting Started tab of the Welcome Center, double-click to open the **Human NIBP** settings file.
2. You should see the device name appear at the top of the new document.
3. The Start button should be enabled and you are now ready to start recording.

## 4. Before starting a measurement

### Apply finger cuff(s)



**Warning!** Finger cuffs will be damaged if allowed to inflate without a finger (or another, appropriately sized object) inside them.

Proper finger cuff application is critical for success with the Human NIBP Nano. Select the proper finger cuff size. If in doubt, choose the smaller finger size cuff.

1. Open the finger cuff just enough to be able to see the LED and photodiode (or photocell, PC).
2. Place the middle, index or ring finger in the cuff. The LED and photocell should be symmetrically placed on each side of the finger's soft parts in the center of the middle phalanx.
3. Lead the cuff cable and air hose in between two fingers to the back of the hand. Here these connect to the Wrist Unit.
4. Make sure the finger cuff is placed centered between two knuckles, touching each knuckle.
5. Wrap the finger cuff tightly for best performance. A common mistake is to not wrap the finger cuff tightly enough.
6. If finger cuff switching is to be used, repeat steps 1–5 to apply a finger cuff to a second finger. Finger-switching is recommended for measurements of 1 hour or longer.

1. Select the correct cuff using the cuff size guide.

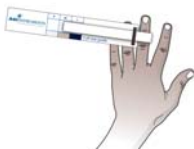

2. Wrap the cuff tightly, preferably around the middle finger, between the joints. Make sure the cable and tube point towards the wrist.



3. Center the LED and photocell symmetrically around the finger.

#### Finger cross-section

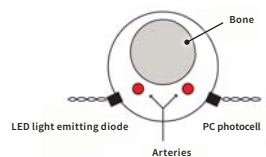



# Instructions

## Zero the HCU

Perform the height correction procedure before attaching the HCU Unit to the volunteer.

1. Hold the HCU transducer and the reference point at the same level.
2. In LabChart, click **Setup > NIBP HCU and test...**
3. In the Human NIBP Settings dialog, click **Zero**.



Once the HCU has successfully been zeroed a confirmation message is displayed.

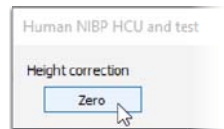

## Apply the Wrist Unit and HCU

The Wrist Unit is connected to the Human NIBP Controller by a cable assembly.

1. Apply the Wrist Unit to the volunteer's wrist and fasten the strap firmly so that it cannot twist.
2. Guide the cable assembly along the arm and fasten the arm straps.
3. Insert the cuff cable and air hose connectors for each finger cuff into the Wrist Unit.
4. Ensure the HCU is connected to the Wrist Unit.
5. The HCU transducer should be attached to the finger cuff and the reference end should be attached at heart level.

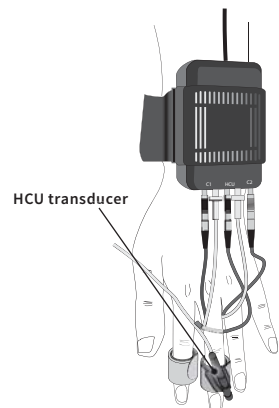
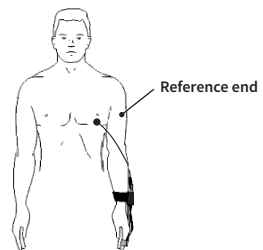

## 5. Choose Human NIBP settings

In LabChart, click **Setup > NIBP Settings...** to open the Settings dialog. The default options are a good starting point.

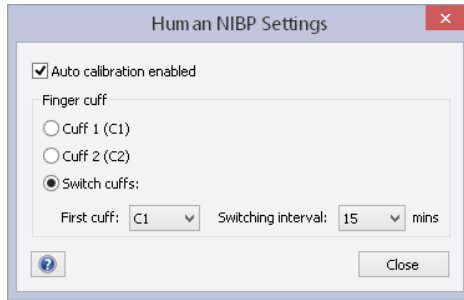

- 1. Auto-calibration (or AutoCal)** – is an ongoing calibration, which greatly improves the accuracy measurements.
  - AutoCal is performed frequently at the start of a measurement but – once the correct, unloaded diameter of the finger artery is established – is repeated only once every 70 heart beats.
  - If the volunteer is moving around a lot, such as during exercise, the AutoCal function does not improve accuracy and should be turned off.
- 2. Finger cuff switching** – select ‘switch cuffs’, and assign the first cuff to start measuring and between 4 switching periods (1, 15, 30 and 60 minutes), or choose to measure a specific cuff **Cuff 1 (C1)** or **Cuff 2 (C2)**.
  - For measurements longer than 1 hour always select finger switching, since a prolonged measurement on one finger can be unpleasant for the volunteer.
  - The 1-minute interval is for testing purposes only.
  - Switching interval can be changed at any time.

## 6. Start a measurement

To start a blood pressure measurement simply click **Start** in LabChart.

### Before you start a measurement...

1. Check that finger cuff(s) are applied and that these are not easy to rotate.
2. Make sure the HCU has been zeroed and is attached to the volunteer.
3. Ensure you have selected your settings for the finger blood pressure measurement in the **NIBP Settings** dialog.

The first time you click **Start**, the following **Warning** dialog will appear:

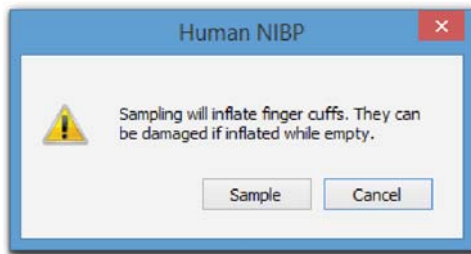

- To proceed, click **Sample**.
- To delay a measurement, click **Cancel**.
- This dialog will not reappear within the same LabChart session.



### Warnings to prevent finger cuff damage:

- Don't apply air pressure to a finger cuff when it is not wrapped around a finger (or any other solid object!) as this will damage the finger cuff.
- Don't remove the finger cuff from a finger before stopping the measurement or before disconnecting the air hose from the Wrist Unit.
- Don't bend finger cuffs outwards into a flat shape.
- Don't attempt to repair defective finger cuffs as this will substantially affect measurement accuracy.

## 7. Stop a measurement

To stop a measurement, simply click Stop in LabChart. Once you have stopped a measurement, it is recommended to:

- 1. Disconnect the finger cuff air hoses from the Wrist Unit** – this removes residual air pressure from the finger cuffs and protects them from accidental inflation and damage.
- 2. Unwrap and remove the finger cuffs** (if you have completed your measurement).
- 3. Inspect the finger after removing a finger cuff** – see if you can find the places where the LED and photodiode have pressed on the finger skin (see Figure below).
  - Verify that the pressure points are correctly centered between the knuckles and symmetrically placed on opposite sides of the finger.
  - The most common reason for inaccurate finger blood pressure readings is incorrect cuff application.
  - If a cuff is applied too tightly, an unrealistically low reading may result.
  - Conversely, if the cuff is applied too loosely, unrealistically high blood pressure readings may occur.

Cuffs are used to measure blood pressure at the finger. Correct sizing and positioning are important to obtain reliable measurement results.



**Incorrect**

Cable and tube  
point in the wrong  
direction



**Incorrect**

Cuff is rotated

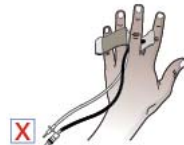

**Incorrect**

Cuff is too close to  
the hand

## 8. Troubleshooting

### 1. If the Human NIBP Nano is returning error messages or failing to start a measurement, it is recommended to:

- Disconnect the finger cuff air hoses from the Wrist Unit.
- Shut down LabChart.
- Turn the Human NIBP Nano Interface off and back on.
- Unplug the USB cable, then reconnect it.
- Reapply the finger cuff(s).
- Restart LabChart before resuming a measurement.

### 2. Operating conditions

- The Human NIBP Nano has a narrow temperature operating range (10–40 °C) and should be placed apart from other equipment for optimal operation.
- It is best to perform measurements at room temperature.
- It is important to keep the hand warm during ambulatory measurements.
- If blood pressure is measured on cold fingers, the measurement can be difficult or even impossible.

### 3. Height correction

- The height reference level should be selected carefully. If the subject is walking or sitting it is best to place the reference part on the chest at the level of the right atrium in the mid-axillary line.
- In the recumbent (lying) position it is best to place the reference ending at mid-chest level.
- If the experiment focuses on the dynamic response of the hemodynamic system after a change in posture it is usually best to keep both the transducer and the reference ending at the level of the right atrium to avoid a dynamic response of the height correction system.
- As a general rule, try to keep the cuffed fingers approximately at heart level, even with a connected height correction unit. The HCU pressure should not exceed  $\pm 20$  mmHg.
- The HCU tubing should be free of bends and unobstructed in any way.

# Further resources

## Statement of intended use

All products supplied by ADInstruments are intended for use in teaching and research applications and environments only.

ADInstruments products are NOT intended to be used as medical devices or in medical environments. That is, no product supplied by ADInstruments is intended to be used to diagnose, treat or monitor a subject. Furthermore no product is intended for the prevention, curing or alleviation of disease, injury or handicap.

This product meets the IEC60601-1 standard, under the principle that:

- it is a more rigorous standard than other standards that could be chosen.
- it provides a high safety level for subjects and operating personnel.

## Avoiding injury to subjects and personnel

- Finger cuffs shouldn't be applied to any body part other than the fingers.
- Do not over tighten the Wrist Unit strap as that will cut off circulation to the hand, leading to discomfort and measurement errors.
- Do not wrap finger cuffs around a toe or the wrist of an infant.
- For safe and reliable operation and optimal accuracy only use finger cuffs manufactured by ADInstruments and FMS.
- Physiological signals acquired by other devices, such as respiratory signals and ECGs, can be connected to the ADInstruments PowerLab system for recording while making blood pressure measurements using the Human NIBP Controller.
- Note that any connected equipment has to meet the IEC specifications (IEC601 for electromedical devices or IEC950 for data processing devices). The configuration has to meet the IEC system standard (IEC601-1-1). Connection of additional devices implies a responsibility to adhere to the IEC601-1-1 standard.
- If any of the components of the Human NIBP System appear damaged in any way, please contact your ADInstruments® representative.

# Product Purchase and License Agreement

This Agreement is between ADInstruments Pty Ltd [‘ADI’] and the purchaser [‘the Purchaser’] of any ADI product or solution — software, hardware or both — and covers all obligations and liabilities on the part of ADI, the Purchaser, and other users of the product. The Purchaser (or any user) accepts the terms of this Agreement by using the product or solution. Any changes to this Agreement must be recorded in writing and have ADI’s and the Purchaser’s consent.

## **Responsibilities**

The Purchaser and any others using any ADI product or solution agree to use it in a sensible manner for purposes for which it is suited, and agree to take responsibility for their actions and the results of their actions. If problems arise with an ADI product, ADI will make all reasonable efforts to rectify them. This service may incur a charge, depending on the nature of the problems, and is subject to the other conditions in this Agreement. ADI does not separately warrant the performance of products, equipment or software manufactured by third parties which may be provided to Purchaser as part of an overall solution. However, as further noted below, ADI will pass through to Purchaser all applicable third party warranties to the extent it has the right to do so.

## **Statement of Intended Use**

Products supplied by ADInstruments are intended for use in teaching and research applications and environments.

Products supplied by ADInstruments are NOT intended to be used as medical devices or in medical environments. That is, no product supplied by ADInstruments is intended to be used to diagnose, treat, or monitor a subject. Furthermore no product is intended for the prevention, curing or alleviation of disease, injury or handicap.

Where a product meets IEC 60601-1 it is under the principle that:

1. it is a more rigorous standard than other standards that could be adopted and
2. it provides the most appropriate safety level for subjects and operators.

The choice to meet IEC 60601-1 is in no way to be interpreted to mean that a product:

1. is a medical device;
2. may be interpreted as a medical device;
3. is safe to be used as a medical device

## **ADI Product Hardware Warranty**

ADI warrants that PowerLab Data Acquisition Units (PL prefix)<sup>1</sup> and Front-ends (FE prefix)<sup>2</sup> shall be free from defects in materials and workmanship for five (5) years from the date of purchase. Other PowerLab Data Acquisition Units<sup>3</sup>, Front-ends<sup>4</sup> and Pods<sup>5</sup> shall be free of

defects in material and workmanship for three (3) years from their date of purchase. ADI also warrants that ADI Specialized Data Recorders<sup>6</sup> and Instruments<sup>7</sup> shall be free of defects in material and workmanship for one (1) year from their date of purchase. If there is such a defect, as Purchaser's sole remedy hereunder, ADI will repair or replace the equipment as appropriate, and the duration of the warranty shall be extended by the length of time needed for repair or replacement.

To obtain service under this warranty, the Purchaser must notify the nearest ADI office, or Authorized Representative, of the defect before the warranty expires. The ADI or Representative office will advise the Purchaser of the nearest service center address to which the Purchaser must ship the defective product at his or her own expense. The product should be packed safely, preferably in its original packaging. ADI will pay return shipping costs.

### **Hardware Warranty Limitations**

This warranty applies only to the ADI hardware specified in this document and used under normal operating conditions and within specification. Consumables, electrodes and accessories are not covered by this warranty. Third party equipment may be covered by the third party manufacturer's warranty. To the extent that ADI has the right to pass through any third party manufacturer warranties to Purchaser it will do so to the extent it is able to do so. Copies of applicable third party manufacturer warranties, to the extent they exist, are available upon request. The warranty provided hereunder does not cover hardware modified in any way, subjected to unusual physical, electrical or environmental stress, used with incorrectly wired or substandard connectors or cables, or with the original identification marks altered. Tampering with or breaking of the Warranty Seal will also void the warranty.

### **Product Types & Warranty Term**

ADI manufactured products covered by five (5) year warranty

1. Data Acquisition Units: PowerLab 35 series with PL prefix.
2. Front-ends: ADI Front-end Signal Conditioners with FE prefix.

ADI manufactured products covered by three (3) year warranty

3. Data Acquisition Units: PowerLab 26 series with ML prefix.
4. Front-ends: ADI Front-end Signal Conditioners with ML prefix.
5. Pods: The entire range of ADI Pod Signal Conditioners.

ADI manufactured products covered by one (1) year warranty

6. Specialized Data Recorders: Metabolic Systems (e.g. ML240 PowerLab/8M Metabolic System)



7. Instruments: Blood FlowMeter, Gas Analyzers, NIBP System (excluding transducers), STH Pump Controller.

#### Third Party Products (Including Transducers)

Products not manufactured by ADI are covered by the manufacturer's warranty.

#### Accessories and Consumables

Accessories and Consumables are not covered by any type of warranty.

### **General Limitations**

ADI products are produced to high standards, and should perform as described in the supplied documentation. There is a limited hardware warranty, and technical support is provided for all ADI products. Nevertheless, since ADI products could be affected by external factors (for instance, the computer system on which they run and other hardware and/or software provided by third parties), absolute performance and reliability of products and the overall solution cannot be guaranteed. No warranty, either expressed or implied or statutory, other than that expressly contained in this Agreement, is made in respect to ADI products or software, third party products or software, the overall solution or otherwise. The Purchaser therefore assumes all risks as to the performance and reliability of the products, the software, the solution and the results gained using them. ADI neither assumes or authorizes any person to assume on its behalf any liability in connection with the sale, installation, service or use of its products. ADI shall not be held responsible for special, consequential or punitive damages of any kind arising out of sale, installation service or use of its products.

EXCEPT FOR THE EXPRESS WARRANTY SET FORTH HEREIN, THE SOLUTION AS WELL AS ALL EQUIPMENT AND SOFTWARE PROVIDED HEREUNDER ARE PROVIDED "AS IS" AND ADI MAKES NO WARRANTY AS TO ITS USE OR PERFORMANCE. EXCEPT FOR ANY WARRANTY, CONDITION, REPRESENTATION OR TERM THE EXTENT TO WHICH CANNOT BE EXCLUDED OR LIMITED BY APPLICABLE LAW, ADI AND ITS SUPPLIERS MAKE NO WARRANTY, CONDITION, REPRESENTATION, OR TERM (EXPRESS OR IMPLIED, WHETHER BY STATUTE, COMMON LAW, CUSTOM, USAGE OR OTHERWISE) AS TO ANY MATTER INCLUDING, WITHOUT LIMITATION, NON INFRINGEMENT OF THIRD PARTY RIGHTS, MERCHANTABILITY, INTEGRATION, OR FITNESS FOR A PARTICULAR PURPOSE. YOU ASSUME RESPONSIBILITY FOR SELECTING THE SOLUTION TO ACHIEVE YOUR INTENDED RESULTS, AND FOR THE INSTALLATION OF, USE OF, AND RESULTS OBTAINED FROM THE EQUIPMENT AND SOFTWARE. WITHOUT LIMITING THE FOREGOING PROVISIONS, ADI MAKES NO WARRANTY THAT THE EQUIPMENT OR SOFTWARE WILL BE ERROR-FREE OR FREE FROM INTERRUPTIONS OR OTHER FAILURES OR THAT THE SOFTWARE OR EQUIPMENT WILL MEET YOUR REQUIREMENTS.

UNDER NO CIRCUMSTANCES AND UNDER NO LEGAL THEORY, WHETHER IN TORT, CONTRACT, OR OTHERWISE, SHALL ADI OR ITS SUPPLIERS BE LIABLE TO PURCHASER OR TO ANY OTHER PERSON FOR LOSS OF PROFITS, LOSS OF GOODWILL, OR ANY INDIRECT, SPECIAL, INCIDENTAL, OR CONSEQUENTIAL DAMAGES, OR DAMAGES FOR GROSS NEGLIGENCE OF ANY CHARACTER INCLUDING, WITHOUT LIMITATION, DAMAGES FOR LOSS OF GOODWILL, WORK STOPPAGE, COMPUTER FAILURE OR MALFUNCTION, OR FOR ANY OTHER DAMAGE OR LOSS. IN NO EVENT SHALL ADI OR ITS SUPPLIERS BE LIABLE FOR ANY DAMAGES IN EXCESS OF THE PRICE PAID FOR THE EQUIPMENT AND SOFTWARE, EVEN IF ADI, OR ITS AUTHORIZED PARTNERS OR SUPPLIERS HAVE BEEN ADVISED OF THE POSSIBILITY OF SUCH DAMAGES.

ADI is acting on behalf of its suppliers for the purpose of disclaiming, excluding and/or limiting obligations, warranties and liability as provided in this agreement, but in no other respects and for no other purpose. The foregoing provisions shall be enforceable to the maximum extent permitted by applicable law.

### **Controlling Law and Severability**

This license shall be governed by the laws of the territory into which the software is sold, or if sold into the United States of America, by the laws of the State of California.

### **Technical Support**

The Purchaser is entitled to free technical support for any ADI product for one year from its date of purchase. Our technical support staff can provide advice concerning installation and operation of ADI products. Services outside of this may incur a charge. Technical support staff will not provide experimental protocols or procedural instructions for conducting experiments. However, information of this type may be provided in the supplied product documentation, or on ADI web sites.

### **Inquiries**

For additional information or service inquiries please contact the nearest ADInstruments office or Authorized Distributor. For contact details see [www.ADIInstruments.com](http://www.ADIInstruments.com)

C006E

Copyright © ADInstruments Pty Ltd, 2000 - 2018. All rights reserved. PowerLab, MacLab, LabChart, LabTutor and LabAuthor are registered trademarks of ADInstruments Pty Ltd. Chart and Scope (application programs), LabTutor Server and LabTutor Online are trademarks of ADInstruments Pty Ltd. The names of specific recording units, such as PowerLab 16/35, are trademarks of ADInstruments Pty Ltd. Windows 8, Windows 7, Windows Vista and .NET Framework are trademarks of Microsoft Corporation. Apple, the Apple logo, MacOS, and Macintosh are trademarks of Apple Computer Inc. registered in the U.S. and other countries. Acrobat and Adobe are registered trademarks of Adobe Systems Incorporated. Igor is a trademark of Wavemetrics Inc. MATLAB is a registered trademark of The MathWorks Inc. Grass is a trademark of Astro-Med Inc. All other trademarks are the property of their respective owners.



